



# Pneumatic Cylinders

Series P1A

According to ISO 6432

Catalogue PDE2564TCUK-ul



Features	Air cylinder	Hydraulic cylinder	Electro mechanical actuators
Overload safe	***	***	*
Easy to limit force	***	***	*
Easy to vary speed	***	***	*
Speed	***	**	**
Reliability	***	***	***
Robustness	***	***	*
Installation cost	***	*	**
Ease of service	***	**	*
Safety in damp environments	***	***	*
Safety in explosive atmospheres	***	***	*
Safety risk with electrical installations	***	***	*
Risk of oil leak	***	*	***
Clean, hygienic	***	**	*
Standardised measurements	***	***	*
Service life	***	***	*
Hydraulic system required	***	*	***
Weight	**	**	**
Purchase price	***	**	*
Power density	**	***	*
Noise level during operation	**	***	**
High force for size	**	***	*
Positioning possibilities	*	***	***
Total energy consumption	*	**	***
Service interval	*	**	***
Compressor capacity required	*	***	***

\* = good, \*\*=average, \*\*\*=excellent



**Important**  
 Before attempting any external or internal work on the cylinder or any connected components, make sure the cylinder is vented and disconnect the air supply in order to ensure isolation of the air supply.



**Note**  
 All technical data in this catalogue are typical data only.  
 Air quality is essential for maximum cylinder service life (see ISO 8573).



**WARNING**

**FAILURE OR IMPROPER SELECTION OR IMPROPER USE OF THE PRODUCTS AND/OR SYSTEMS DESCRIBED HEREIN OR RELATED ITEMS CAN CAUSE DEATH, PERSONAL INJURY AND PROPERTY DAMAGE.**

This document and other information from Parker Hannifin Corporation, its subsidiaries and authorized distributors provide product and/or system options for further investigation by users having technical expertise. It is important that you analyze all aspects of your application and review the information concerning the product or system in the current product catalog. Due to the variety of operating conditions and applications for these products or systems, the user, through its own analysis and testing, is solely responsible for making the final selection of the products and systems and assuring that all performance, safety and warning requirements of the application are met. The products described herein, including without limitation, product features, specifications, designs, availability and pricing, are subject to change by Parker Hannifin Corporation and its subsidiaries at any time without notice.

**SALE CONDITIONS**

The items described in this document are available for sale by Parker Hannifin Corporation, its subsidiaries or its authorized distributors. Any sale contract entered into by Parker will be governed by the provisions stated in Parker's standard terms and conditions of sale (copy available upon request).

<b>Contents</b>	<b>Page</b>
ISO cylinder series P1A.....	4-5
Cylinder forces .....	6
Main data.....	7
Working medium, air quality .....	7
Material specification .....	8
Cushioning diagram .....	8
Dimensions.....	9
Guide for selecting suitable tubing .....	10-11
Valve series with respective flows in NI/minute .....	11
Order key.....	12
Stroke length .....	12
Order codes single-acting P1A .....	13
Order codes double-acting P1A .....	14-15
P1A with rod guidance modules .....	16
Dimensions, rod guidance modules.....	17
Mountings.....	18-21
Sensors .....	22-25
Connecting cables with one connector.....	26
Male connectors for connecting cables.....	26
Ready to use connecting cables with connectors at each end .....	26
Connection block Valvetronic 110.....	27

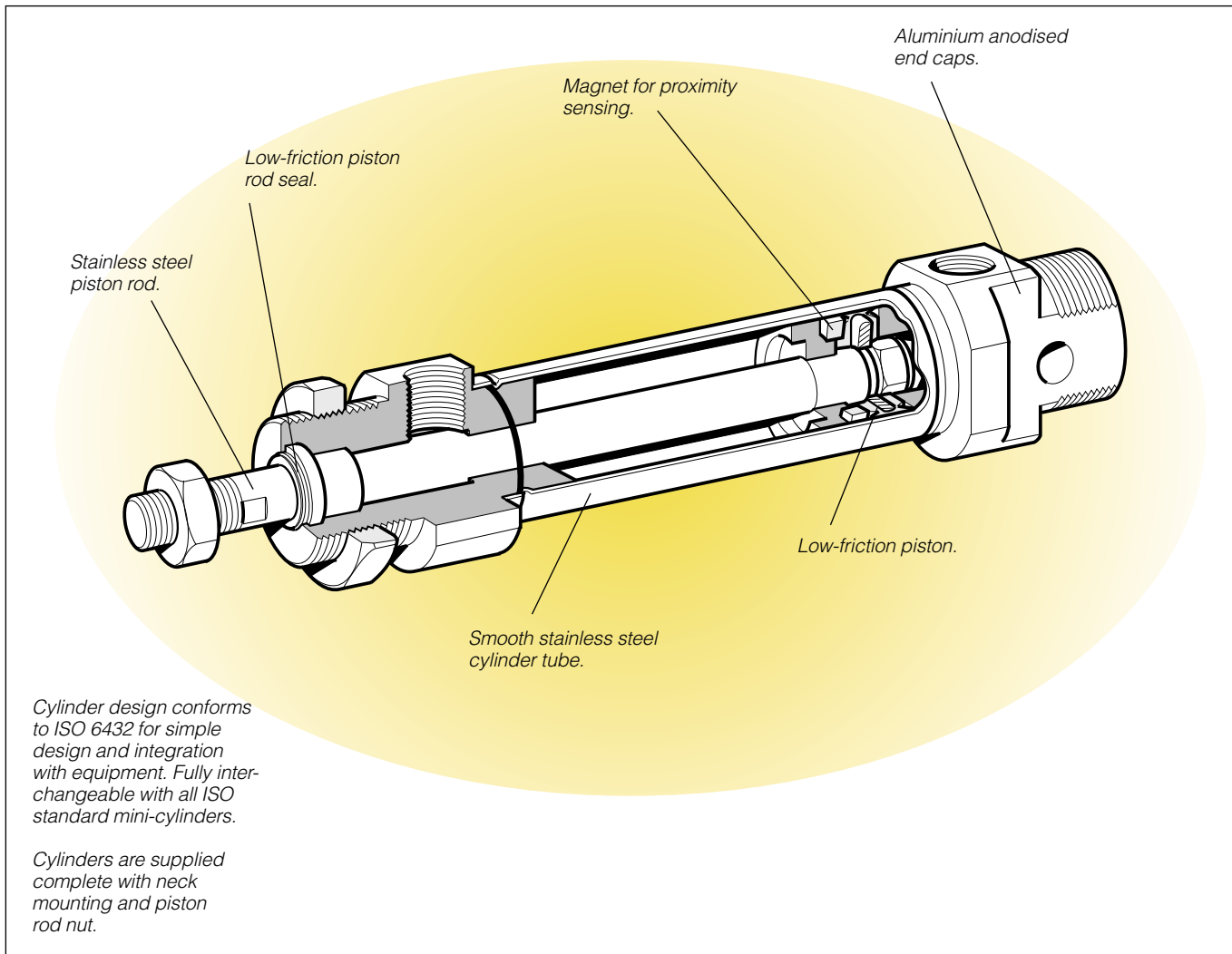

## Double and single-acting versions

The P1A range of cylinders is intended for use in a wide range of applications. The cylinders are particularly suitable for lighter duties in the packaging, food and textile industries.

Hygienic design, the use of corrosion-resistant materials and initial lubrication with our food-grade grease makes the cylinders suitable for food industry applications.

Careful design and high quality manufacture throughout ensure long service life and optimum economy.

Mounting dimensions fully in accordance with ISO 6432 and CETOP RP52P greatly simplifies installation and world-wide interchangeability.

The cylinders are available in bores of 10, 12, 16, 20 and 25 mm, with stroke lengths from 10 mm to 320 mm.

Single-acting cylinders with spring return in the retract direction are available in stroke lengths up to 80 mm.

Single-acting cylinders with spring return in the advance direction are available in 16 mm, 20 mm and 25 mm bore sizes and with stroke lengths up to 80 mm.

## Double-acting cushioned cylinders

Adjustable pneumatic cushioning permits greater loads and higher operating speeds, making the cylinders suitable for more demanding duties.

These cylinders are available in bores of 16, 20 and 25 mm, with stroke lengths from 20 mm to 500 mm.

### Options

In addition to a wide range of standard cylinders, Mini ISO cylinders are available in several standard variants, such as non-standard stroke length, extended piston rods, double piston rods, high and low-temperature versions etc. In addition, a complete range of sensors and mountings are available.

### Effective cushioning

The Mini ISO range is available with fixed end cushioning or with adjustable pneumatic cushioning, controlled by simple bleed screws for fine adjustment. The adjustable cushioned cylinders can be operated with higher mass loads and at higher speeds than those with fixed end cushioning, reducing overall cycle times.

### Smooth external design

There are no recesses or pockets in the end covers that could trap dirt or liquid, making cleaning simple and effective.

### Corrosion-resistant

Even the basic versions of the cylinders have good corrosion resistance through appropriate choice of materials and surface treatment, allowing them to be used in demanding environments.

### Stainless steel versions

The Mini ISO range is also available in an all-stainless version with piston rod, barrel and end covers of stainless steel for use in particularly severe environments. See separate brochure for cylinder series P1S.

### Proximity sensing

A complete range of sensors for proximity sensing is available as accessories: both reed switch and Hall effect sensors are available. They are supplied with either flying lead or cable plug connector.

### Complete mounting programme

A complete ISO compatible mounting programme with surface-treated/stainless steel piston rod and cylinder mountings for both pivoted and fixed operation are available.

### Variants

In addition to the basic versions, a number of standard variants of Parker Pneumatics cylinders are available to meet exacting demands on function and environmental adaptation:

Non-standard stroke lengths

Extended piston rods

Through piston rods

Single acting cylinder with spring return (in the retract direction).

Single acting cylinder with spring return in the advance direction (piston rod in extended position)

External guide, for controlled guidance of the piston rod

High-temperature cylinder versions for use in ambient temperatures ranging from -10 °C to +150 °C for bores 12, 16, 20 and 25 mm

Cylinders with outer sealings in fluorocarbon

Stainless steel cylinders, see brochure for series P1S

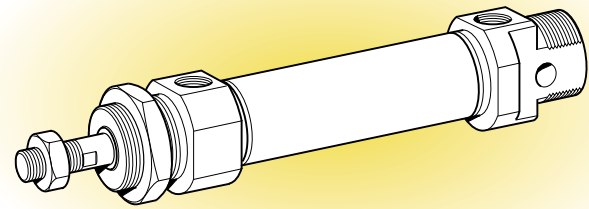

Double-acting, cushioned stroke

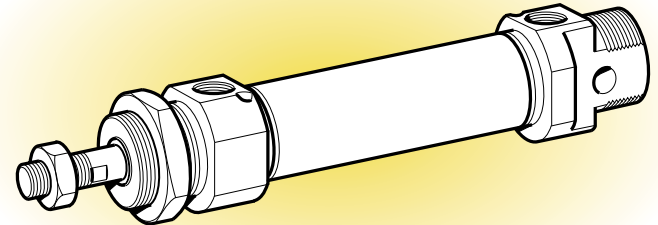

Double-acting, adjustable cushioning

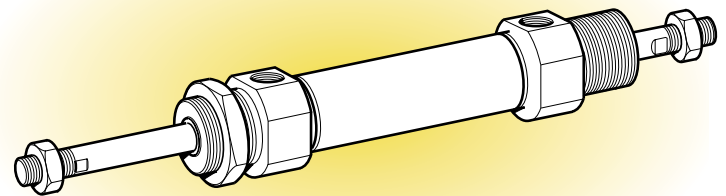

Double-acting, through piston rod

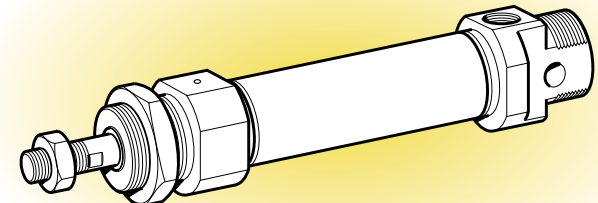

Single-acting, spring return

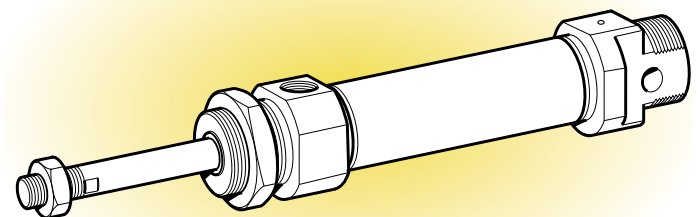

Single-acting, spring-extended

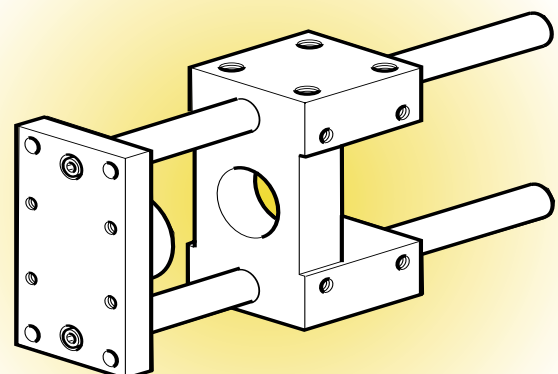

Double-acting, external guide device

**Cylinder forces, double acting variants**

Cyl. bore/ pist. rod mm	Stroke	Pistonarea cm <sup>2</sup>	Max theoretical force in N (bar)									
			1,0	2,0	3,0	4,0	5,0	6,0	7,0	8,0	9,0	10,0
<b>10/4</b>	+	0,8	8	16	24	31	39	<b>47</b>	55	63	71	79
	-	0,7	7	13	20	26	33	<b>40</b>	46	53	59	66
<b>12/6</b>	+	1,1	11	23	34	45	57	<b>68</b>	79	90	102	113
	-	0,8	8	17	25	34	42	<b>51</b>	59	68	76	85
<b>16/6</b>	+	2,0	20	40	60	80	100	<b>120</b>	141	161	181	201
	-	1,7	17	35	52	69	86	<b>104</b>	121	138	156	173
<b>20/8</b>	+	3,1	31	63	94	126	157	<b>188</b>	220	251	283	314
	-	2,6	26	53	79	106	132	<b>158</b>	185	211	238	264
<b>25/10</b>	+	4,9	49	98	147	196	245	<b>295</b>	344	393	442	491
	-	4,1	41	82	124	165	206	<b>247</b>	289	330	371	412

+ = Outward stroke  
- = Return stroke

**Note!**  
Select a theoretical force 50-100% larger than the force required

**Cylinder forces single acting variants**

Indicated cylinder forces are theoretical and should be reduced according to the working conditions.

Order code	Theoretical piston force at 6 bar			
	Nmax	Nmin	Spring retraction	
			Nmax	Nmin
<b>Single acting, spring return</b>				
P1A-S010SS-0010	38	36	10	8,5
P1A-S010SS-0015	38	36	10	7,8
P1A-S010SS-0025	39	36	10	6,6
P1A-S010SS-0040	38	34	13	9
P1A-S010SS-0050	39	34	13	8
P1A-S010SS-0080	39	34	12	7
P1A-S012SS-0010	53	51	16	14,4
P1A-S012SS-0015	53	51	16	13,6
P1A-S012SS-0025	55	51	16	12
P1A-S012SS-0040	52	48	19	13,4
P1A-S012SS-0050	53	48	19	12
P1A-S012SS-0080	55	48	21,4	12
P1A-S016SS-0010	102	99	22,3	20,2
P1A-S016SS-0015	103	99	22,3	19
P1A-S016SS-0025	105	99	22,3	17
P1A-S016SS-0040	106	95	22,3	14
P1A-S016SS-0050	108	95	22,3	12
P1A-S016SS-0080	107	95	22,5	12
P1A-S020SS-0010	163	161	30	28
P1A-S020SS-0015	164	161	30	27
P1A-S020SS-0025	167	161	30	25
P1A-S020SS-0040	166	159	30	22
P1A-S020SS-0050	168	159	30	20
P1A-S020SS-0080	170	161	29,4	18
P1A-S025SS-0010	256	253	44,3	41,4
P1A-S025SS-0015	258	253	44,3	40
P1A-S025SS-0025	262	253	44,3	37
P1A-S025SS-0040	261	250	44,3	32
P1A-S025SS-0050	264	250	44,3	30
P1A-S025SS-0080	264	251	44,4	30
<b>Single acting, spring-extended</b>				
P1A-S016TS-0010	85	84	22,3	20,2
P1A-S016TS-0015	86	84	22,3	19
P1A-S016TS-0025	88	84	22,3	17
P1A-S016TS-0040	90	84	22,3	14
P1A-S016TS-0050	91	84	22,3	12
P1A-S020TS-0010	132	130	30	28
P1A-S020TS-0015	133	130	30	27
P1A-S020TS-0025	135	130	30	25
P1A-S020TS-0040	138	130	30	22
P1A-S020TS-0050	140	130	30	20
P1A-S020TS-0080	139	108	31	17
P1A-S025TS-0010	205	203	38,5	36
P1A-S025TS-0015	207	203	38,5	34,7
P1A-S025TS-0025	210	203	38,5	32
P1A-S025TS-0040	214	203	38,5	28,5
P1A-S025TS-0050	217	203	38,5	26
P1A-S025TS-0080	223	206	36	21

## Main data

Cylinder designation	Cylinder		Piston rod			Total mass		Air consumption	Conn. thread
	bore	area	bore	area	thread	at 0 mm stroke	addition per 10 mm stroke		
	mm	cm <sup>2</sup>	mm	cm <sup>2</sup>		kg	kg	litres	
<b>Double acting, cushioned stroke</b>									
P1A-S010D	10	0,78	4	0,13	M4	0,04	0,003	0,0100 <sup>1)</sup>	M5
P1A-S012D	12	1,13	6	0,28	M6	0,07	0,004	0,0139 <sup>1)</sup>	M5
P1A-S016D	16	2,01	6	0,28	M6	0,09	0,005	0,0262 <sup>1)</sup>	M5
P1A-S020D	20	3,14	8	0,50	M8	0,18	0,007	0,0405 <sup>1)</sup>	G1/8
P1A-S025D	25	4,91	10	0,78	M10x1,25	0,25	0,011	0,0633 <sup>1)</sup>	G1/8
<b>Double acting, adjustable cushioning</b>									
P1A-S016M	16	2,01	6	0,28	M6	0,09	0,005	0,0262 <sup>1)</sup>	M5
P1A-S020M	20	3,14	8	0,50	M8	0,18	0,007	0,0405 <sup>1)</sup>	G1/8
P1A-S025M	25	4,91	10	0,78	M10x1,25	0,25	0,011	0,0633 <sup>1)</sup>	G1/8
<b>Single acting, spring return</b>									
P1A-S010SS	10	0,78	4	0,13	M4	0,04	0,003	0,0055 <sup>1)</sup>	M5
P1A-S012SS	12	1,13	6	0,28	M6	0,08	0,004	0,0079 <sup>1)</sup>	M5
P1A-S016SS	16	2,01	6	0,28	M6	0,10	0,005	0,0141 <sup>1)</sup>	M5
P1A-S020SS	20	3,14	8	0,50	M8	0,18	0,007	0,0220 <sup>1)</sup>	G1/8
P1A-S025SS	25	4,91	10	0,78	M10x1,25	0,26	0,011	0,0344 <sup>1)</sup>	G1/8
<b>Single acting, spring-extended</b>									
P1A-S016TS	16	2,01	6	0,28	M6	0,10	0,005	0,0141 <sup>1)</sup>	M5
P1A-S020TS	20	3,14	8	0,50	M8	0,18	0,007	0,0220 <sup>1)</sup>	G1/8
P1A-S025TS	25	4,91	10	0,78	M10x1,25	0,26	0,011	0,0344 <sup>1)</sup>	G1/8

1) Free air consumption per 10 mm stroke length for a double stroke at 6 bar

## Working medium, air quality

Working medium Dry, filtered compressed air to ISO 8573-1 class 3.4.3.

## Recommended air quality for cylinders

For best possible service life and trouble-free operation, ISO 8573-1 quality class 3.4.3 should be used. This means 5 µm filter (standard filter) dew point +3 °C for indoor operation (a lower dew point should be selected for outdoor operation) and oil concentration 1.0 mg oil/m<sup>3</sup>, which is what a standard compressor with a standard filter gives.

## ISO 8573-1 quality classes

Quality class	Pollution		Water max. press. dew point (°C)	Oil max concentration (mg/m <sup>3</sup> )
	particle size (µm)	max concentration (mg/m <sup>3</sup> )		
1	0,1	0,1	-70	0,01
2	1	1	-40	0,1
3	5	5	-20	1,0
4	15	8	+3	5,0
5	40	10	+7	25
6	-	-	+10	-

## Additional data

Working pressure max 10 bar  
Working temperature max +80 °C  
min -20 °C

High-temperature version max +150 °C  
(Ø12, 16, 20 and 25 mm)min -10 °C

Prelubricated, further lubrication is not normally necessary. If additional lubrication is introduced it must be continued.



**Material specification**

Piston rod	Stainless steel, DIN X 10 CrNiS 18 9
Piston rod seal	Nitrile rubber, NBR
Piston rod bearing	Multilayer PTFE/steel
End covers	Anodized aluminium
O-ring, internal	Nitrile rubber, NBR
Cylinder barrel	Stainless steel, DIN X 5 CrNi 18 10
Piston, complete	Nitrile rubber, NBR/steel
Magnet holder	Thermoplastic elastomer
Magnet	Plastic-coated magnetic material
Return spring	Surface-treated steel
Cushioning screw	Stainless steel, DIN X 10 CrNiS 18 9

**Variants Mini ISO:**

**Low-temperature version, type L:**

Piston rod seal	Nitrile rubber, NBR
Piston complete	Nitrile rubber, NBR/steel

**High-temperature version, type F:**

Piston rod seal	Fluorocarbon rubber, FPM
Piston complete	HNBR/steel

**Cylinders with outer sealings in fluorocarbon, type V:**

Piston rod seal/ Scraper ring	Fluorocarbon rubber, FPM
----------------------------------	--------------------------

Spare part = new cylinder

**Cushioning diagram**

Use the diagram below to determine the necessary size of cylinder to provide the requisite cushioning performance. The maximum cushioning performance, as indicated in the diagram, is based on the following assumptions:

- Low load, i.e. low pressure drop across the piston
- Steady-state piston speed
- Correctly adjusted cushioning screw

The load is the sum of the internal and external friction, together with any gravity forces. At high relative loading it is recommended that, for a given speed, the load should be reduced by a factor of 2.5, or that, for a given mass, the speed should be reduced by a factor of 1.5. These factors apply in relation to the maximum performance as shown in the diagram.

Fixed end-cushioning  
Speed [m/s]

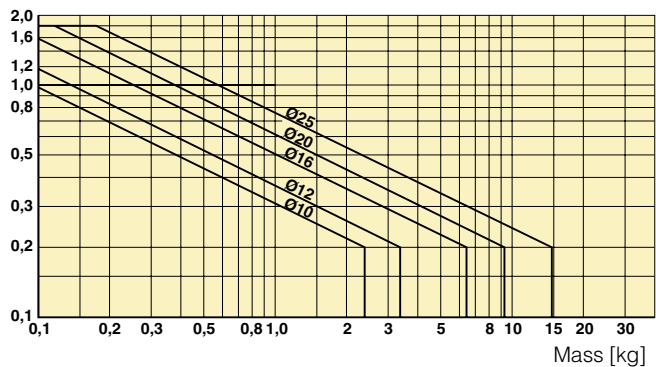

Adjustable pneumatic end-cushioning  
Speed [m/s]

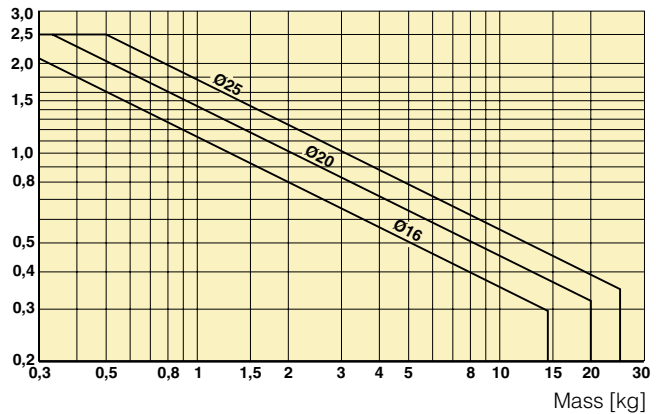



## Dimensions

### Double and single acting cylinders

### CAD drawings on the Internet

Our home page [www.parker.com/euro\\_pneumatic](http://www.parker.com/euro_pneumatic) includes the AirCad Drawing Library with 2D and 3D drawings for the main versions.

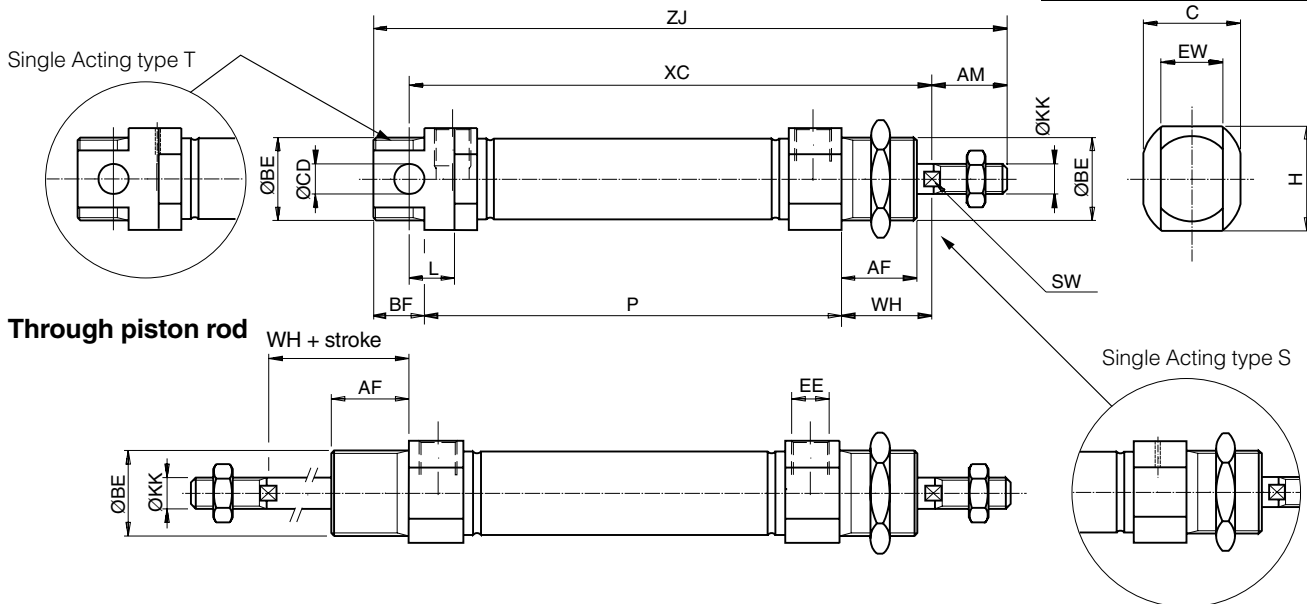

Cylinder bore mm	AM 0/-2 mm	BE	AF mm	BF mm	C mm	CDH <sup>9</sup> mm	EE	EW mm	H mm	KK	L mm	SW mm	WH $\pm$ 1,2 mm
10	12	M12x1,25	12	10	13,0	4	M5	8	13,0	M4	6	-	16
12	16	M16x1,5	18	13	17,8	6	M5	12	17,8	M6	9	5	22
16 <sup>1)</sup>	16	M16x1,5	18	13	17,8	6	M5	12	17,8	M6	9	5	22
16 <sup>2)</sup>	16	M16x1,5	18	13	23,8	6	M5	12	23,8	M6	9	5	22
20	20	M22x1,5	20	14	23,8	8	G1/8	16	23,8	M8	12	7	24
25	22	M22x1,5	22	14	26,8	8	G1/8	16	26,8	M10x1,25	12	9	28

1) P1A-S016DS/SS/TS

2) P1A-S016MS

### Double acting cylinders

Cylinder bore mm	XC mm	ZJ mm	P mm
10	64 + stroke	84 + stroke	46 + stroke
12	75 + stroke	99 + stroke	48 + stroke
16	82 + stroke	104 + stroke	53 + stroke
20	95 + stroke	125 + stroke	67 + stroke
25	104 + stroke	132 + stroke	68 + stroke

### Single-acting, spring return, type SS

Stroke/ Cylinder bore mm	10 mm	15 mm	25 mm	40 mm	50 mm	80 mm	10 mm	15 mm	25 mm	40 mm	50 mm	80 mm	10 mm	15 mm	25 mm	40 mm	50 mm	80 mm
	XC	XC	XC	XC	XC	XC	ZJ	ZJ	ZJ	ZJ	ZJ	ZJ	P	P	P	P	P	P
10	74	79	89	126	136	174	94	99	109	146	156	194	56	61	71	108	118	156
12	85	90	100	132	142	185	109	114	124	156	166	209	58	63	73	105	115	158
16	92	97	107	122	132	184	114	119	129	144	154	206	63	68	78	93	103	155
20	105	110	120	135	145	191	135	140	150	165	175	221	77	82	92	107	117	163
25	114	119	129	144	154	201	142	147	157	172	182	229	78	83	93	108	118	165

### Single-acting, spring-extended, type TS

Stroke/ Cylinder bore mm	10 mm	15 mm	25 mm	40 mm	50 mm	80 mm	10 mm	15 mm	25 mm	40 mm	50 mm	80 mm	10 mm	15 mm	25 mm	40 mm	50 mm	80 mm
	XC <sup>3)</sup>	XC <sup>3)</sup>	XC <sup>3)</sup>	XC <sup>3)</sup>	XC <sup>3)</sup>	XC <sup>3)</sup>	ZJ <sup>3)</sup>	ZJ <sup>3)</sup>	ZJ <sup>3)</sup>	ZJ <sup>3)</sup>	ZJ <sup>3)</sup>	ZJ <sup>3)</sup>	P	P	P	P	P	P
16	107	112	122	137	147	-	129	134	144	159	169	-	78	83	93	108	118	-
20	120	125	135	150	160	195	150	155	165	180	190	225	92	97	107	122	132	167
25	129	134	144	159	169	205	157	162	172	187	197	233	93	98	108	123	133	169

3) With piston rod retracted, as shown in the dimension drawing

Length tolerances  $\pm 1$  mm

Stroke length tolerances  $+1,5/0$  mm

### Guide for selecting suitable tubing

The selection of the correct size of tubing is often based on experience, with no great thought to optimizing energy efficiency and cylinder velocity. This is usually acceptable, but making a rough calculation can result in worthwhile economic gains.

#### The following is the basic principle:

1. The primary line to the working valve could be over sized (this does not cause any extra air consumption and consequently does not create any extra costs in operation).
2. The tubes between the valve and the cylinder should, however, be optimized according to the principle that an insufficient bore throttles the flow and thus limits the cylinder speed, while an oversized pipe creates a dead volume which increases the air consumption and filling time.

The chart below is intended to help when selecting the correct size of tube to use between the valve and the cylinder.

#### The following prerequisites apply:

The cylinder load should be about 50% of the theoretical force (= normal load). A lower load gives a higher velocity and vice versa. The tube size is selected as a function of the cylinder bore, the desired cylinder velocity and the tube length between the valve and the cylinder.

If you want to use the capacity of the valve to its maximum, and obtain maximum speed, the tubing should be chosen so that they at least correspond with the equivalent restriction diameter (see description below), so that the tubing does not restrict the total flow. This means that a short tubing must have at least the equivalent restriction diameter. If the tubing is longer, choose it from the table below. Straight fittings should be chosen for highest flow rates. (Elbow and banjo fittings cause restriction.)

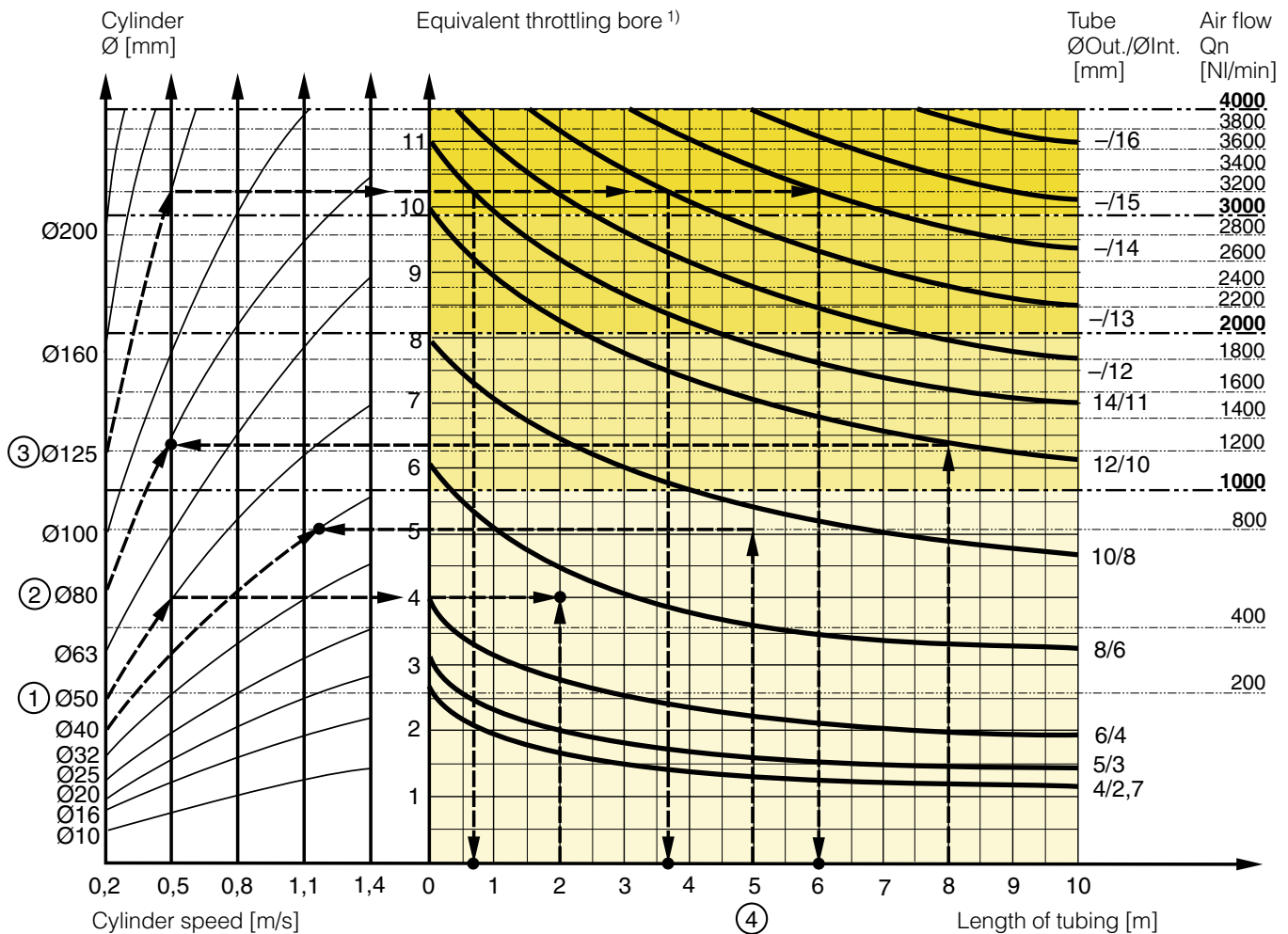

- 1) The "equivalent throttling bore" is a long throttle (for example a tube) or a series of throttles (for example, through a valve) converted to a short throttle which gives a corresponding flow rate. This should not be confused with the "orifice" which is sometimes specified for valves. The value for the orifice does not normally take account of the fact that the valve contains a number of throttles.
- 2) Qn is a measure of the valve flow capacity, with flow measured in litre per minute (l/min) at 6 bar(e) supply pressure and 1 bar pressure drop across the valve.

**Example ① : Which tube diameter should be used?**

A 50 mm bore cylinder is to be operated at 0.5 m/s. The tube length between the valve and cylinder is 2 m. In the diagram we follow the line from 50 mm bore to 0.5 m/s and get an "equivalent throttling bore" of approximately 4 mm. We continue out to the right in the chart and intersect the line for a 2 m tube between the curves for 4 mm (6/4 tube) and 6 mm (8/6 tube). This means that a 6/4 tube throttles the velocity somewhat, while an 8/6 tube is a little too large. We select the 8/6 tube to obtain full cylinder velocity.

**Example ②: What cylinder velocity will be obtained?**

A 80 mm bore cylinder will be used, connected by 8 m 12/10 tube to a P2L-B valve. What cylinder velocity will we get? We refer to the diagram and follow the line from 8 mm tube length up to the curve for 12/10 tube. From there, we go horizontally to the curve for the Ø80 cylinder. We find that the velocity will be about 0.5 m/s.

**Example ③: What is the minimum inner diameter and maximum length of tube?**

For an application a 125 mm bore cylinder will be used. Maximum velocity of piston rod is 0.5 m/s. The cylinder will be controlled by a P2L-D valve. What diameter of tube can be used and what is maximum length of tube. We refer to the diagram. We start at the left side of the diagram cylinder Ø125. We follow the line until the intersection with the velocity line of 0.5 m/s. From here we draw a horizontal line in the diagram. This line shows us we need an equivalent throttling bore of approximately 10 mm. Following this line horizontally we cross a few intersections. These intersections shows us the minimum inner diameter (rightside diagram) in combination with the maximum length of tube (bottomside diagram).

For example:

Intersection one: When a tube (14/11) will be used, the maximum length of tube is 0.7 meter.

Intersection two: When a tube (—/13) will be used, the maximum length of tube is 3.7 meter.

Intersection three: When a tube (—/14) will be used, the maximum length of tube is 6 meter.

**Example 4 : Determining tube size and cylinder velocity with a particular cylinder and valve?**

For an application using a 40 mm bore cylinder with a valve with  $Q_n=800$  NI/min. The distance between the cylinder and valve has been set to 5 m.

**Tube dimension:** What tube bore should be selected to obtain the maximum cylinder velocity? Start at pipe length 5 m, follow the line up to the intersection with 800 NI/min. Select the next largest tube diameter, in this case Ø10/8 mm.

**Cylinder velocity:** What maximum cylinder velocity will be obtained? Follow the line for 800 NI/min to the left until it intersects with the line for the Ø40 mm cylinder. In this example, the speed is just above 1.1 m/s.

**Valve series with respective flows in NI/minute**

Valve series	Qn in NI/Min
Valvetronic Solstar	33
Interface PS1	100
Valvetronic Interface 2000	100
B2 Series	168
Adex A05	173
Moduflex size 1, (2 x 3/2)	220
Valvetronic PVL-B 5/3 closed centre, 6 mm push in	290
Moduflex size 1, (4/2)	320
B43 Manual and mechanical	340
Valvetronic PVL-B 2 x 2/3, 6 mm push in	350
Valvetronic PVL-B 5/3 closed centre, G1/8	370
Compact Isomax DX02	385
Valvetronic PVL-B 2 x 3/2 G1/8	440
Valvetronic PVL-B 5/2, 6 mm push in	450
Valvetronic PVL-B 5/3 vented centre, 6 mm push in	450
Moduflex size 2, (2 x 3/2)	450
Flowstar P2V-A	520
Valvetronic PVL-B 5/3 vented centre, G1/8	540
Valvetronic PVL-B 5/2, G1/8	540
Valvetronic PVL-C 2 x 3/2, 8 mm push in	540
Adex A12	560
Valvetronic PVL-C 2 x 3/2 G1/8	570
Compact Isomax DX01	585
Valvetronic PVL-C 5/3 closed centre, 8 mm push in	700
Valvetronic PVL-C 5/3 vented centre, G1/4	700
VIKING P2L-A	760
B3 Series	780
Valvetronic PVL-C 5/3 closed centre, G1/4	780
Moduflex size 2, (4/2)	800
Valvetronic PVL-C 5/2, 8 mm push in	840
Valvetronic PVL-C 5/3 vented centre, 8 mm push in	840
Valvetronic PVL-C 5/2, G1/4	840
VIKING P2L-B	1020
Flowstar P2V-B	1090
ISOMAX DX1	1150
B53 Manual and mechanical	1160
B4 Series	1170
Airline Isolator Valve VE22/23	1470
ISOMAX DX2	2330
VIKING P2L-D	2880
ISOMAX DX3	4050
Airline Isolator Valve VE42/43	5520
Airline Isolator Valve VE82/83	13680







Order key

<b>P1A-S</b>	<b>016</b>	<b>M</b>	<b>S</b>	<b>-</b>	<b>0025</b>
--------------	------------	----------	----------	----------	-------------

Cylinder bore mm
010
012
016
020
025

  

Cylinder type / function
<b>M</b>  Double-acting, adjustable cushioning. Ø16-25 mm. Not for sealing material type F and L
<b>D</b>  Double-acting, non-adjustable cushioning, Ø10 - Ø25
<b>F</b>  Double-acting, adjustable cushioning, thru-rod, Ø16-25 mm. Not for sealing material type F and L
<b>K</b>  Double-acting, non-adjustable cushioning, thru-rod, Ø10 - Ø25
<b>S</b>  Single-acting, non-adjustable cushioning, spring return for retract stroke, Ø10-25 mm
<b>T</b>  Single-acting, non-adjustable cushioning, spring return for advance stroke, Ø16-25 mm

Stroke length, mm
E.g. 0025 = 25 mm For standard stroke length and max length see label below.

Sealing material
<b>S</b> Standard, -20 °C to +80 °C. Magnetic piston
<b>F</b>  High temperature, Ø12, 16, 20 and 25 mm -10 °C to +150 °C. Not magnetic piston
<b>V</b> External seals of fluorinated rubber. -20 °C to +80 °C. Magnetic piston

Stroke length

Cylinder designation	Cylinder bore	Standard stroke length in mm										Non standard stroke length									
		10	15	20	25*	30	40	50*	80*	100*	125*	160*	200*	250*	320*	400*	500*				
<b>Double acting with fixed end-cushioning:</b>																					
P1A-S010D	10	●	●	●	●	●	●	●	●	●	●	●	●	●	●	●	●				
P1A-S012D	12	●	●	●	●	●	●	●	●	●	●	●	●	●	●	●	●				
P1A-S016D	16	●	●	●	●	●	●	●	●	●	●	●	●	●	●	●	●				
P1A-S020D	20	●	●	●	●	●	●	●	●	●	●	●	●	●	●	●	●				
P1A-S025D	25	●	●	●	●	●	●	●	●	●	●	●	●	●	●	●	●				
<b>Double acting with adjustable end-cushioning:</b>																					
P1A-S016M	16	●	●	●	●	●	●	●	●	●	●	●	●	●	●	●	●				
P1A-S020M	20	●	●	●	●	●	●	●	●	●	●	●	●	●	●	●	●				
P1A-S025M	25	●	●	●	●	●	●	●	●	●	●	●	●	●	●	●	●				
<b>Single acting, spring return:</b>																					
P1A-S010SS	10	●	●	●	●	●	●	●	●	●	●	●	●	●	●	●	●				
P1A-S012SS	12	●	●	●	●	●	●	●	●	●	●	●	●	●	●	●	●				
P1A-S016SS	16	●	●	●	●	●	●	●	●	●	●	●	●	●	●	●	●				
P1A-S020SS	20	●	●	●	●	●	●	●	●	●	●	●	●	●	●	●	●				
P1A-S025SS	25	●	●	●	●	●	●	●	●	●	●	●	●	●	●	●	●				
<b>Single acting, spring-extended:</b>																					
P1A-S016TS	16	●	●	●	●	●	●	●	●	●	●	●	●	●	●	●	●				
P1A-S020TS	20	●	●	●	●	●	●	●	●	●	●	●	●	●	●	●	●				
P1A-S025TS	25	●	●	●	●	●	●	●	●	●	●	●	●	●	●	●	●				

\*Standard stroke lengths in mm according to ISO 4393

## Data

Working pressure max. 10 bar  
 Working temperature max. +80 °C  
 min. -20 °C



## Single-acting spring return

Fixed end cushioning

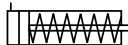

Cyl.bore mm	Stroke mm	Order code
<b>10</b> Conn. M5	10	P1A-S010SS-0010
	15	P1A-S010SS-0015
	25	P1A-S010SS-0025
	40	P1A-S010SS-0040
	50	P1A-S010SS-0050
	80	P1A-S010SS-0080
<b>12</b> Conn. M5	10	P1A-S012SS-0010
	15	P1A-S012SS-0015
	25	P1A-S012SS-0025
	40	P1A-S012SS-0040
	50	P1A-S012SS-0050
	80	P1A-S012SS-0080
<b>16</b> Conn. M5	10	P1A-S016SS-0010
	15	P1A-S016SS-0015
	25	P1A-S016SS-0025
	40	P1A-S016SS-0040
	50	P1A-S016SS-0050
	80	P1A-S016SS-0080
<b>20</b> Conn. G1/8	10	P1A-S020SS-0010
	15	P1A-S020SS-0015
	25	P1A-S020SS-0025
	40	P1A-S020SS-0040
	50	P1A-S020SS-0050
	80	P1A-S020SS-0080
<b>25</b> Conn. G1/8	10	P1A-S025SS-0010
	15	P1A-S025SS-0015
	25	P1A-S025SS-0025
	40	P1A-S025SS-0040
	50	P1A-S025SS-0050
	80	P1A-S025SS-0080

## Single-acting spring extended

Fixed end cushioning



Cyl.bore mm	Stroke mm	Order code
<b>16</b> Conn. M5	10	P1A-S016TS-0010
	15	P1A-S016TS-0015
	25	P1A-S016TS-0025
	40	P1A-S016TS-0040
	50	P1A-S016TS-0050
<b>20</b> Conn. G1/8	10	P1A-S020TS-0010
	15	P1A-S020TS-0015
	25	P1A-S020TS-0025
	40	P1A-S020TS-0040
	50	P1A-S020TS-0050
	80	P1A-S020TS-0080
<b>25</b> Conn. G1/8	10	P1A-S025TS-0010
	15	P1A-S025TS-0015
	25	P1A-S025TS-0025
	40	P1A-S025TS-0040
	50	P1A-S025TS-0050
	80	P1A-S025TS-0080

Cylinders are supplied complete with neck mounting and piston rod nuts.

Cylinders are supplied complete with neck mounting and piston rod nuts.

## Data

Working pressure	max. 10 bar
Working temperature	max. +80 °C min. -20 °C



## Double-acting

### Fixed end cushioning

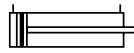

Cyl.bore mm	Stroke mm	Order code	
<b>10</b> Conn. M5	10	P1A-S010DS-0010	
	15	P1A-S010DS-0015	
	20	P1A-S010DS-0020	
	25	P1A-S010DS-0025	
	30	P1A-S010DS-0030	
	40	P1A-S010DS-0040	
	50	P1A-S010DS-0050	
	80	P1A-S010DS-0080	
	100	P1A-S010DS-0100	
	125	P1A-S010DS-0125	
Max stroke 500 mm			
<b>12</b> Conn. M5	10	P1A-S012DS-0010	
	15	P1A-S012DS-0015	
	20	P1A-S012DS-0020	
	25	P1A-S012DS-0025	
	30	P1A-S012DS-0030	
	40	P1A-S012DS-0040	
	50	P1A-S012DS-0050	
	80	P1A-S012DS-0080	
	100	P1A-S012DS-0100	
	125	P1A-S012DS-0125	
	160	P1A-S012DS-0160	
	200	P1A-S012DS-0200	
	Max stroke 500 mm		
<b>16</b> Conn. M5	10	P1A-S016DS-0010	
	15	P1A-S016DS-0015	
	20	P1A-S016DS-0020	
	25	P1A-S016DS-0025	
	30	P1A-S016DS-0030	
	40	P1A-S016DS-0040	
	50	P1A-S016DS-0050	
	80	P1A-S016DS-0080	
	100	P1A-S016DS-0100	
	125	P1A-S016DS-0125	
	160	P1A-S016DS-0160	
	200	P1A-S016DS-0200	
	Max stroke 500 mm		

### Fixed end cushioning

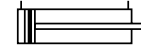

Cyl.bore mm	Stroke mm	Order code
<b>20</b> Conn. G1/8	10	P1A-S020DS-0010
	15	P1A-S020DS-0015
	20	P1A-S020DS-0020
	25	P1A-S020DS-0025
	30	P1A-S020DS-0030
	40	P1A-S020DS-0040
	50	P1A-S020DS-0050
	80	P1A-S020DS-0080
	100	P1A-S020DS-0100
	125	P1A-S020DS-0125
	160	P1A-S020DS-0160
	200	P1A-S020DS-0200
	250	P1A-S020DS-0250
	320	P1A-S020DS-0320
Max stroke 1000 mm		
<b>25</b> Conn. G1/8	10	P1A-S025DS-0010
	15	P1A-S025DS-0015
	20	P1A-S025DS-0020
	25	P1A-S025DS-0025
	30	P1A-S025DS-0030
	40	P1A-S025DS-0040
	50	P1A-S025DS-0050
	80	P1A-S025DS-0080
	100	P1A-S025DS-0100
	125	P1A-S025DS-0125
	160	P1A-S025DS-0160
	200	P1A-S025DS-0200
	250	P1A-S025DS-0250
	320	P1A-S025DS-0320
Max stroke 1000 mm		

Cylinders are supplied complete with neck mounting and piston rod nuts.

Cylinders with Through piston rods are supplied with two piston rod nuts and one neck mounting nut.

## Data

Working pressure	max. 10 bar
Working temperature	max. +80 °C min. -20 °C



## Double-acting

### Adjustable cushioning



Cyl.bore mm	Stroke mm	Order code	
<b>16</b> Conn. M5	20	P1A-S016MS-0020	
	25	P1A-S016MS-0025	
	30	P1A-S016MS-0030	
	40	P1A-S016MS-0040	
	50	P1A-S016MS-0050	
	80	P1A-S016MS-0080	
	100	P1A-S016MS-0100	
	125	P1A-S016MS-0125	
	160	P1A-S016MS-0160	
	200	P1A-S016MS-0200	
	250	P1A-S016MS-0250	
	320	P1A-S016MS-0320	
	400	P1A-S016MS-0400	
	Max stroke 500 mm	500	P1A-S016MS-0500
	<b>20</b> Conn. G1/8	20	P1A-S020MS-0020
25		P1A-S020MS-0025	
30		P1A-S020MS-0030	
40		P1A-S020MS-0040	
50		P1A-S020MS-0050	
80		P1A-S020MS-0080	
100		P1A-S020MS-0100	
125		P1A-S020MS-0125	
160		P1A-S020MS-0160	
200		P1A-S020MS-0200	
250		P1A-S020MS-0250	
320		P1A-S020MS-0320	
400		P1A-S020MS-0400	
Max stroke 1000 mm		500	P1A-S020MS-0500

Cyl.bore mm	Stroke mm	Order code	
<b>25</b> Conn. G1/8	20	P1A-S025MS-0020	
	25	P1A-S025MS-0025	
	30	P1A-S025MS-0030	
	40	P1A-S025MS-0040	
	50	P1A-S025MS-0050	
	80	P1A-S025MS-0080	
	100	P1A-S025MS-0100	
	125	P1A-S025MS-0125	
	160	P1A-S025MS-0160	
	200	P1A-S025MS-0200	
	250	P1A-S025MS-0250	
	320	P1A-S025MS-0320	
	400	P1A-S025MS-0400	
	Max stroke 1000 mm	500	P1A-S025MS-0500

Cylinders are supplied complete with neck mounting and piston rod nuts.  
Cylinders with Through piston rods are supplied with two piston rod nuts and one neck mounting nut.



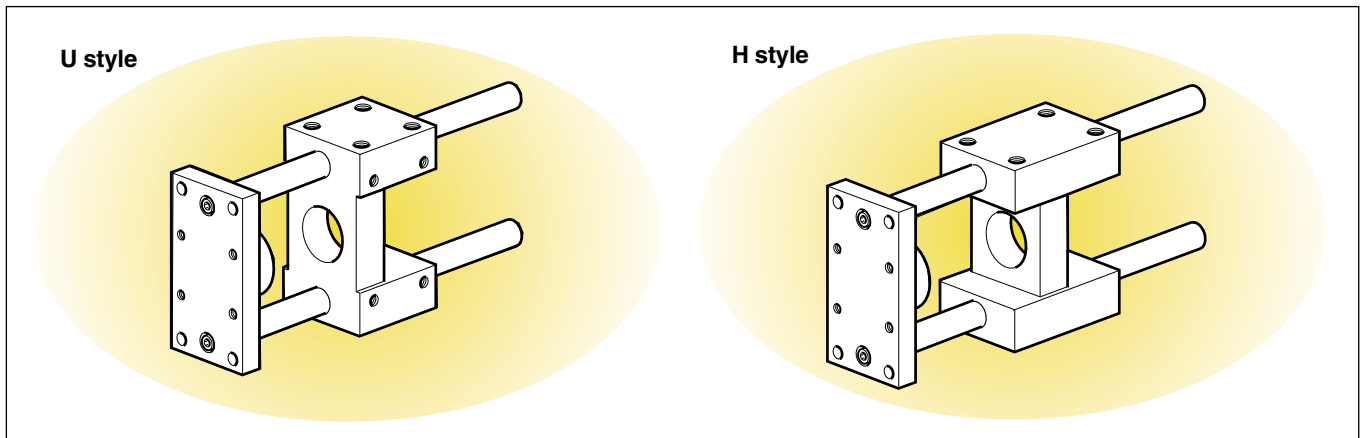

**P1A with rod guidance modules**

The P1A series cylinders can be equipped with an external guiding device to prevent the piston rod from turning. When fitted the guide provides a guided piston movement enabling the cylinder to resist turning moments on the piston rod, as well as greater transverse forces. Rod guides are available with plain bearings as U style or linear ball bearings as H style.

The bracket, which has pre-drilled mounting holes, is connected to the piston rod by means of a flexocoupling, which prevents the build-up of stress in the cylinder.

P1A cylinders with guiding device are available with bores from 12 to 25 mm, and stroke lengths up to 250 mm. Separate guiding device kits can be supplied on request according to the order key below.

**Technical data**

Working pressure max 10 bar  
 Working temperature -20 °C to +80 °C

**Material specifications, guidance modules**

Body Anodised aluminium  
 Guide bars, H style Hardened stainless steel  
 Front plate Anodised aluminium  
 Guide bars, U style Stainless steel  
 Front plate Zinc-plated steel  
 Plain bearings Bronze

Other data as standard cylinder.

**Order key**

P1A
-
4DRH
-
XXXX

Cylinder version		Bore size mm		Guide module type		Stroke length (mm)	
<b>A</b>	Mini ISO cylinders	<b>D</b>	12, 16	<b>H</b>	H style, ball bearings	Same as for the cylinder	
		<b>H</b>	20	<b>K</b>	U style, plain bearings		
		<b>J</b>	25				

**Transverse force as a function of load distance**

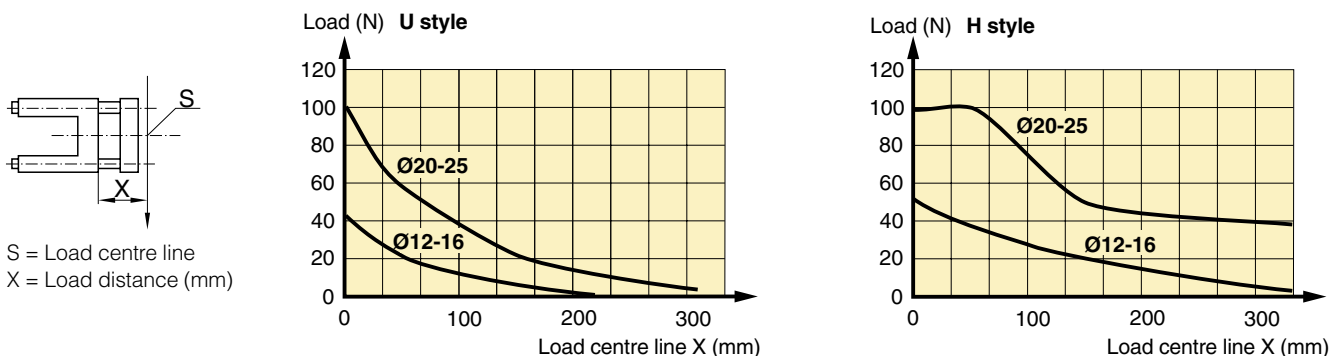

## Dimensions, U style guidance modules

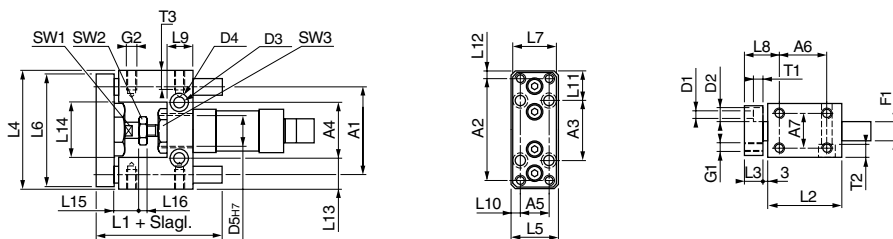

Cyl. bore	A1	A2	A3	A4	A5	A6	A7	D1	D2	D3	D4	D5 <sup>H7</sup>	F1	G1
12/16	46	54	32	24	15	25,0	22	4,5	8	5,5	-	16	8	M4
20	58	68	40	38	20	32,5	23	5,5	10	6,6	11	22	10	M5
25	58	68	40	38	20	32,5	23	5,5	10	6,6	11	22	10	M5

Cyl. bore	G2	L1	L2	L3	L4	L5	L6	L7	L8 <sup>+5/-0</sup>	L9	L10	L11
12/16	M4	69	39	10	65	30	63	27	19,5	19	7,5	16,5
20	M6	85	55	12	79	34	76	32	24,0	25	7,0	19,5
25	M6	85	55	12	79	34	76	32	24,0	25	7,0	19,5

Cyl. bore	L12	L13	L14	L15	L16	T1	T2	T3	SW1	SW2	SW3
12/16	5,5	20,5	27	12	3,2	4,6	-	8	9	10	19
20	5,5	20,5	37	29	4,0	5,7	7	14	13	13	27
25	5,5	20,5	37	23	6,0	5,7	7	14	13	17	27

## Dimensions, H style guidance modules

Ø12 to Ø16 mm

Ø20 to Ø25 mm

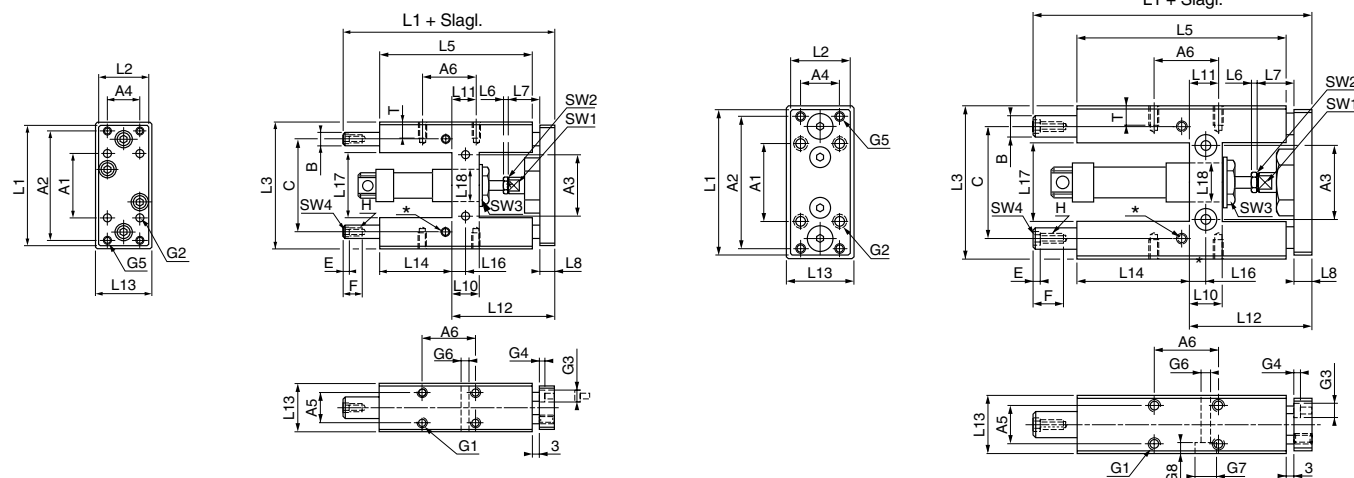

Cyl. bore	A1	A2	A3	A4	A5	A6	B	C	E	F	H	G1	G2	G3	G4
12/16	32	54	24	15	22	32,5	8	46	4	12	M3	M4	4,5	8	4,6
20	40	68	38	20	23	32,5	10	58	5	14	M4	M6	5,5	10	5,7
25	40	68	38	20	23	32,5	10	58	5	14	M4	M6	5,5	10	5,7

Cyl. bore	G5	G6	G7	G8	L1	L2	L3	L4	L5	L6	L7	L8	L10	L11	L12
12/16	M4	5,5	-	-	63	27	65	130	75	32	12	10	13	11	51 <sup>+5</sup>
20	M5	6,6	11	7	76	32	79	160	108	22	12	17	15	32	65 <sup>+5</sup>
25	M5	6,6	11	7	76	32	79	160	108	17	12	17	15	32	65 <sup>+5</sup>

Cyl. bore	L13	L14	L16	L17	L18 <sup>H7</sup>	T	SW1	SW2	SW3	SW4
12/16	30	37	6,5	27	16	8	9	10	19	4
20	34	58	8,5	37	22	14	13	13	27	5
25	34	58	8,5	37	22	14	13	17	27	5

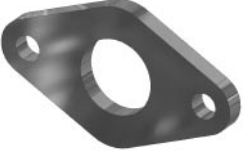
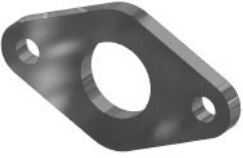

\* Lubrication point

## Cylinder mountings

Type	Description	Cyl. bore Ø mm	Weight kg	Order code
<b>Flange-MF8</b> 	Intended for fixed attachment of the cylinder. The flange is designed for mounting on the front or rear end-covers.  Material: Surface-treated steel	10	0,012	<b>P1A-4CMB</b> <b>P1A-4DMB</b> <b>P1A-4HMB</b>
		12-16	0,025	
		20-25	0,045	
<b>Stainless Flange-MF8</b> 	Intended for fixed attachment of the cylinder. The flange is designed for mounting on the front or rear end-covers.  Material: Stainless steel, DIN X 10 CrNiS 18 9	10	0,012	<b>P1S-4CMB</b> <b>P1S-4DMB</b> <b>P1S-4HMB</b>
		12-16	0,025	
		20-25	0,045	

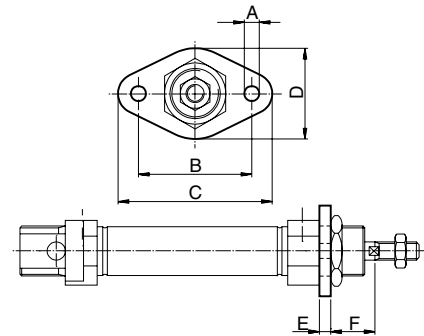
Cylinder Ø mm	A mm	B mm	C mm	D mm	E mm	F mm
10	4,5	30	40	22	3	13
12-16	5,5	40	52	30	4	18
20	6,6	50	66	40	5	19
25	6,6	50	66	40	5	23



<b>Foot-MS3</b> 	Intended for fixed attachment of the cylinder. The bracket is designed for mounting on the front or rear end-covers.  Material: Surface-treated steel	10	0,020	<b>P1A-4CMF</b> <b>P1A-4DMF</b> <b>P1A-4HMF</b>
		12-16	0,040	
		20-25	0,080	
<b>Stainless Foot-MS3</b> 	Intended for fixed attachment of the cylinder. The bracket is designed for mounting on the front or rear end-covers.  Material: Stainless steel, DIN X 10 CrNiS 18 9	10	0,020	<b>P1S-4CMF</b> <b>P1S-4DMF</b> <b>P1S-4HMF</b>
		12-16	0,040	
		20-25	0,080	

Cylinder Ø mm	A mm	B mm	C mm	D mm	E mm	F mm	G mm	H mm	I mm
10	4,5	16	25	35	3	24	26,0	16	11
12-16	5,5	20	32	42	4	32	32,5	20	14
20	6,5	25	40	54	5	36	45,0	25	17
25	6,5	25	40	54	5	40	45,0	25	17

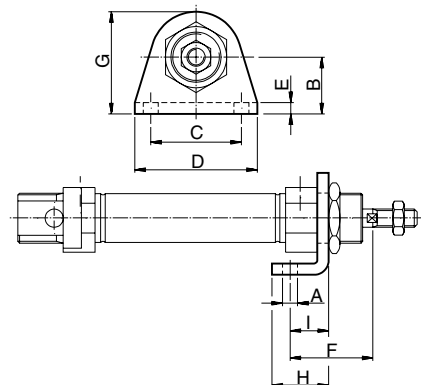

## Cylinder mountings

Type	Description	Cyl. bore Ø mm	Weight kg	Order code
<b>Cover trunnion</b>	Intended for articulated mounting of the cylinder. The flange is designed for mounting on the front or rear end-covers.  Material: Surface-treated steel	10	0,014	<b>P1A-4CMJZ</b> <b>P1A-4DMJZ</b> <b>P1A-4HMJZ</b>
		12-16	0,033	
		20-25	0,037	

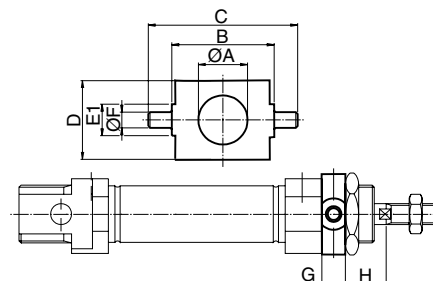
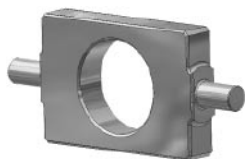

Cylinder Ø mm	A mm	B h14 mm	C mm	D mm	E1 mm	F e9 mm	G mm	H mm
10	12,5	26	38	20	9	4	6	10
12-16	16,5	38	58	25	13	6	8	14
20	22,5	46	66	30	13	6	8	16
25	22,5	46	66	30	13	6	8	20

## Cover trunnion Stainless steel

Intended for articulated mounting of the cylinder. The flange is designed for mounting on the front or rear end-covers.

10	0,014	<b>P1A-4CMJ</b> <b>P1A-4DMJ</b> <b>P1A-4HMJ</b>
12-16	0,033	
20-25	0,037	



Material:  
Stainless steel, DIN X 10 CrNiS 18 9

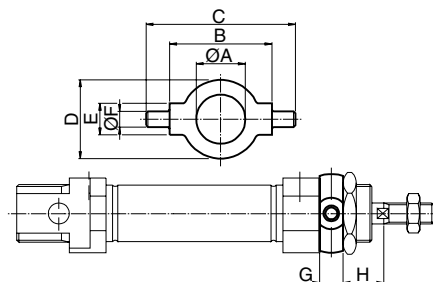

Cylinder Ø mm	A mm	B h14 mm	C mm	D mm	E mm	F e9 mm	G mm	H mm
10	12,5	26	38	20	8	4	6	10
12-16	16,5	38	58	25	10	6	8	14
20	22,5	46	66	30	10	6	8	16
25	22,5	46	66	30	10	6	8	20

## Stainless Mounting nut

Intended for fixed mounting of the cylinder.  
Cylinders are supplied complete with one mounting nut.

10	0,009	<b>9126725405</b> <b>9126725406</b> <b>9126725407</b>
12-16	0,018	
20-25	0,042	



Material:  
Stainless steel, DIN X 5 CrNi 18 10

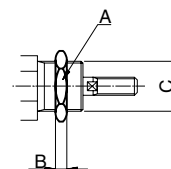

Cylinder Ø mm	A mm	B mm	C
10	19	6	M12x1,25
12-16	24	8	M16x1,50
20-25	32	11	M22x1,50

## Cylinder mountings

Type	Description	Cyl. bore Ø mm	Weight kg	Order code
<b>Clevis bracket</b>	Intended for articulated mounting of the cylinder. Supplied with shaft for mounting on the rear end cover.	10	0,020	<b>P1A-4CMT</b> <b>P1A-4DMT</b> <b>P1A-4HMT</b>
		12-16	0,040	
		20-25	0,080	



Material:  
Bracket: surface-treated steel, black  
Pin: surface hardened steel  
Circlips: according to DIN 471: Stainless steel

## Clevis bracket



Intended for articulated mounting of the cylinder. Supplied with shaft for mounting on the rear end cover.

10	0,020
12-16	0,040
20-25	0,080

**P1S-4CMT**  
**P1S-4DMT**  
**P1S-4HMT**

Material:  
Bracket: stainless steel, DIN X 5 CrNi 18 10  
Pin: tempered stainless steel, DIN X 20 Cr 13  
Locking rings: stainless steel, DIN X 5 CrNi 18 10

Cylinder Ø mm	A mm	B mm	C mm	D mm	E mm	F mm	G mm	H mm	I °	J °
10	4,5	13	8	24	12,5	20	65,3	5	160	17
12	5,5	18	12	27	15,0	25	73,0	7	170	15
16	5,5	18	12	27	15,0	25	80,0	7	170	15
20	6,5	24	16	30	20,0	32	91,0	10	165	10
25	6,5	24	16	30	20,0	32	100,0	10	165	10

S=stroke

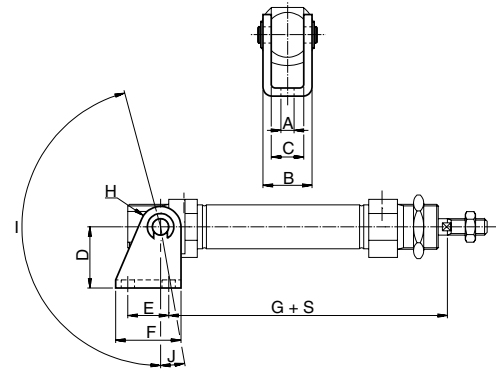

## Clevis



According to ISO 8140  
Intended for articulated mounting of the cylinder. This mounting is adjustable in the axial direction. Supplied complete with pin.

10	0,007
12-16	0,022
20	0,045
25	0,095

**P1A-4CRC**  
**P1A-4DRC**  
**P1A-4HRC**  
**P1A-4JRC**

Material:  
Galvanized steel

## Stainless Clevis



According to ISO 8140  
Intended for articulated mounting of the cylinder. This mounting is adjustable in the axial direction. Supplied complete with pin.

10	0,007
12-16	0,022
20	0,045
25	0,095

**P1S-4CRC**  
**P1S-4DRC**  
**P1S-4HRC**  
**P1S-4JRC**

Material:  
Stainless steel, DIN X 5 CrNi 18 10

Cylinder Ø mm	A mm	B	C mm	D mm	E mm	F mm	G mm	H mm	I mm	J mm
10	4	M4	2,2	8	8	5	16	4	22,0	2,0
12-16	6	M6	3,2	12	12	7	24	6	31,0	3,0
20	8	M8	4,0	16	16	10	32	8	40,5	3,5
25	10	M10x1,25	5,0	20	20	12	40	10	49,0	3,0

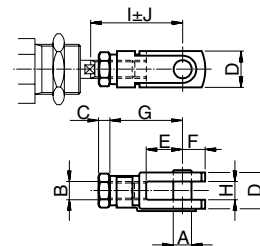



## Cylinder mountings

Type	Description	Cyl. bore Ø mm	Weight kg	Order code
<b>Swivel rod eye</b> 	According to ISO 8139 Intended for articulated mounting of the cylinder. This mounting is adjustable in the axial direction.  Material: Swivel rod eye: Galvanized steel Ball: hardened steel	10	0,017	<b>P1A-4CRS</b> <b>P1A-4DRS</b> <b>P1A-4HRS</b> <b>P1A-4JRS</b>
		12-16	0,025	
		20	0,045	
		25	0,085	

<b>Stainless Swivel rod eye</b> 	According to ISO 8139 Intended for articulated mounting of the cylinder. This mounting is adjustable in the axial direction.  Material: Swivel rod eye: stainless steel, DIN X 5 CrNi 18 10 Ball: hardened stainless steel, DIN X 5 CrNi 18 10	10	0,017	<b>P1A-4CRS</b> <b>P1A-4DRS</b> <b>P1A-4HRS</b> <b>P1A-4JRS</b>
		12-16	0,025	
		20	0,045	
		25	0,085	

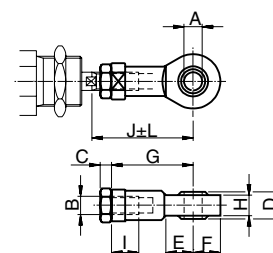
Cylinder Ø mm	A mm	B	C mm	D mm	E mm	F mm	G mm	H mm	I mm	J mm	K mm	L mm
10	5	M4	2,2	8	10	9	27	6,0	8	33,0	9	2,0
12-16	6	M6	3,2	9	10	10	30	6,8	9	38,5	11	1,5
20	8	M8	4,0	12	12	12	36	9,0	12	46,0	14	2,0
25	10	M10x1,25	5,0	14	14	14	43	10,5	15	52,5	17	2,5



<b>Stainless Rod nut</b> 	Intended for fixed mounting on the piston rod. Cylinders are supplied complete with one rod nut. (cylinders with through piston rod are supplied with two rod nuts.)  Material: Stainless steel, DIN X 5 CrNi 18 10	10	0,001	<b>9127385121</b> <b>9127385122</b> <b>9127385123</b> <b>9126725404</b>
		12-16	0,002	
		20	0,005	
		25	0,007	

Cylinder Ø mm	D	F mm	E mm
10	M4	7	2,2
12-16	M6	10	3,2
20	M8	13	4,0
25	M10x1,25	17	5,0

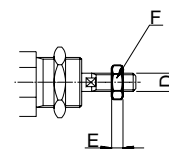

## Our global series of sensors

This series of sensors is already being used or will be used in all future ranges in our global product programme involving cylinders/actuators. The sensors have small installation dimensions and either fit into the groove in the case profile or, as shown here, are fastened to the cylinder using a special attachment.

You can choose from electronic or reed sensors with a range of cable lengths fitted with 8 mm or M12 terminals.



### Electronic sensors

The new electronic sensors are "Solid State", i.e. they have no moving parts at all. They are provided with short-circuit protection and transient protection as standard. The built-in electronics make the sensors suitable for applications with high on and off switching frequency, and where very long service life is required.

#### Technical data

Design	GMR (Giant Magnetic Resistance) magneto-resistive function
Installation	Sensor mounting P8S-TMC01
Outputs	PNP, normally open (also available in NPN design, normally closed, on request)
Voltage range	10-30 VDC 10-18 V DC, ATEX sensor
Ripple	max 10%
Voltage drop	max 2,5 V
Load current	max 100 mA
Internal consumption	max 10 mA
Actuating distance	min 9 mm
Hysteresis	max 1,5 mm
Repeatability accuracy	max 0,2 mm
On/off switching frequency	max 5 kHz
On switching time	max 2 ms
Off switching time	max 2 ms
Encapsulation	IP 67 (EN 60529)
Temperature range	-25 °C to +75 °C -20 °C to +45 °C, ATEX sensor
Indication	LED, yellow
Material housing	PA 12
Material screw	Stainless steel
Cable	PVC or PUR 3x0.25 mm <sup>2</sup> see order code respectively

### Reed sensors

The sensors are based on proven reed switches, which offer reliable function in many applications. Simple installation, a protected position on the cylinder and clear LED indication are important advantages of this range of sensors.

#### Technical data

Design	Reed element
Mounting	Sensor mounting P8S-TMC01
Output	Normally open , or normally closed
Voltage range	10-30 V AC/DC or 10-120 V AC/DC 24-230 V AC/DC
Load current	max 500 mA for 10-30 V or max 100 mA for 10-120 V max 30 mA for 24-230 V
Breaking power (resistive)	max 6 W/VA
Actuating distance	min 9 mm
Hysteresis	max 1,5 mm
Repeatability accuracy	0,2 mm
On/off switching frequency	max 400 Hz
On switching time	max 1,5 ms
Off switching time	max 0,5 ms
Encapsulation	IP 67 (EN 60529)
Temperature range	-25 °C to +75 °C
Indication	LED, yellow
Material housing	PA12
Material screw	Stainless steel
Cable	PVC or PUR 3x0.14 mm <sup>2</sup> see order code respectively



## Electronic sensors

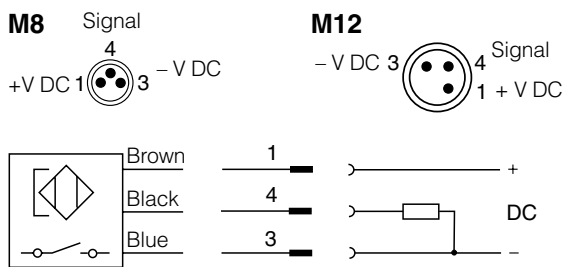

## Reed sensors

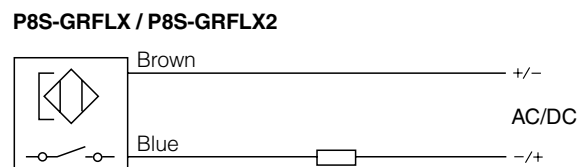
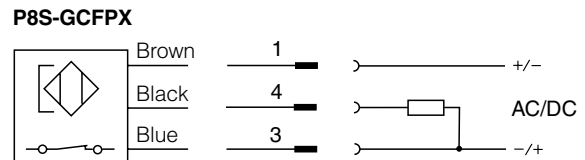
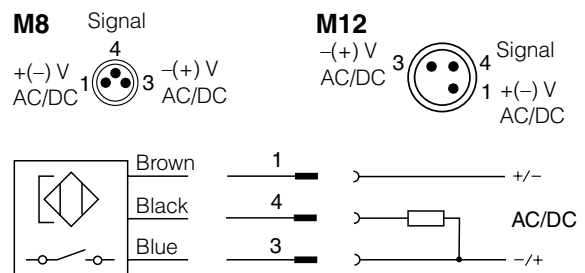

## Dimensions

### Sensors

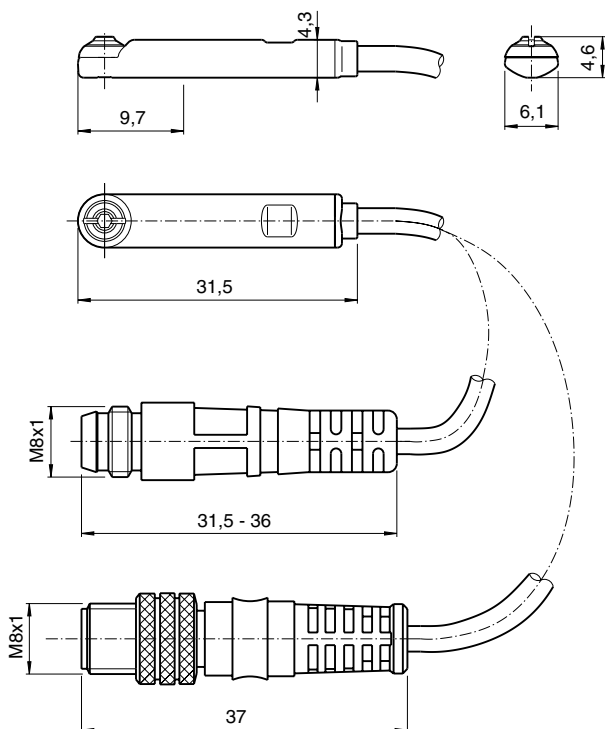

### Sensor mounting P8S-TMC01

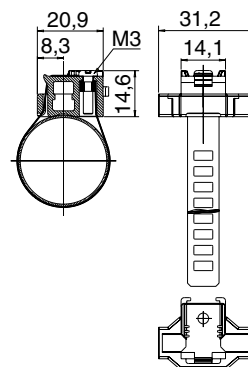

## Ordering data

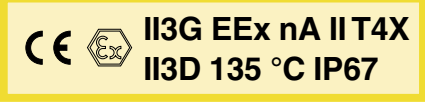
Output/function	Cable/connector	Weight kg	Order code
<b>Electronic sensors , 10-30 V AC/DC</b>			
PNP type, normally open	0,27 m PUR-cable and 8 mm snap-in male connector	0,007	<b>P8S-GPSHX</b>
PNP type, normally open	1,0 m PUR-cable and 8 mm snap-in male connector	0,013	<b>P8S-GPSCX</b>
PNP type, normally open	1,0 m PUR-cable and M8 screw male connector	0,013	<b>P8S-GPCCX</b>
PNP type, normally open	0,27 m PUR-cable and M12 screw male connector	0,015	<b>P8S-GPMHX</b>
PNP type, normally open	3 m PVC-cable without connector	0,030	<b>P8S-GPFLX</b>
PNP type, normally open	10 m PVC-cable without connector	0,110	<b>P8S-GPFTX</b>
<b>Electronic sensor 18-30 V DC ATEX-certified</b>			
			
Type PNP , normally open	3 m PVC-cable without connector	0,030	<b>P8S-GPFLX/EX</b>
<b>Reed sensors , 10-30 V AC/DC</b>			
Normally open	0,27 m PUR-cable and 8 mm snap-in male connector	0,007	<b>P8S-GSSHX</b>
Normally open	1,0 m PUR-cable and 8 mm snap-in male connector	0,013	<b>P8S-GSSCX</b>
Normally open	1,0 m PUR-cable and M8 male connector	0,013	<b>P8S-GSCCX</b>
Normally open	0,27 m PUR-cable and M12 screw male connector	0,015	<b>P8S-GSMHX</b>
Normally open	1,0 m PUR-cable and M12 screw male connector	0,023	<b>P8S-GSMCX</b>
Normally open	3 m PVC-cable without connector	0,030	<b>P8S-GSFLX</b>
Normally open	10 m PVC-cable without connector	0,110	<b>P8S-GSFTX</b>
Normally closed	5 m PVC-cable without connector <sup>1)</sup>	0,050	<b>P8S-GCFPX</b>
<b>Reed sensors, 10-120 V AC/DC</b>			
Normally open	3 m PVC-cable without connector	0,030	<b>P8S-GRFLX</b>
<b>Reed sensorer, 24-230 V AC/DC</b>			
Normalt öppen	3 m PVC-kabel utan kontakt <sup>1)</sup>	0,030	<b>P8S-GRFLX2</b>

1) Without LED

## Sensor mounting

Description	Weight kg	Order code
Sensor mounting for cylinder P1A cylinder bore Ø10 to Ø25 mm	0,07	<b>P8S-TMC01</b>

## Sensors for special applications

Sensors for applications where the short installation length and the 90 degree cable outlet are important factors. This type of sensor is a good alternative if a cylinder has a short stroke or tight installation, and installation is easier than our global series of sensors.

### Technical data

Design	Hall element
Output	PNP resp. NPN, N.O.
Voltage range	10-30 VDC
Max permissible ripple	10%
Max voltage drop	≤0,5 V at 100 mA
Max load current, P1A-2XMK, LK	150 mA
P1A-2XHk, EK, JH, FH	100 mA
Max breaking power (resistive)	6 W
Internal consumption	<30 mA at 30 V
Min actuating distance	5 mm
Hysteresis	1,1 - 1,3 mm
Repeatability accuracy	±0,1 mm
Max on/off switching frequency	1 kHz
Max on/off switching time	0,8/3,0 μs
Encapsulation, P1A-2XJH, FH	IP 65
Encapsulation, P1A-2XHk, EK, MK, LK	IP 67
Temperature range	-10 °C to +60 °C
Indication	LED
Shock resistance	40 g
Material, housing	Polyamid 11
Material, mould	Epoxy
Cable	PVC 3x0,15 mm <sup>2</sup>
Cable incl. female part connector	PVC 3x0,15 mm <sup>2</sup>
Connector	Diam. 8 mm snap on
Mounting	Mounting yoke
Material, mounting	Acetal/Stainless steel
Material, screw	Stainless steel

### Ordering data

Output	Cable length	Weight kg	Order code
<b>Electronic sensors</b>			
PNP, N.O.	2 m	0,040	<b>P1A-2XMK</b>
NPN, N.O.	2 m	0,040	<b>P1A-2XLK</b>
<b>Mountngs for sensors</b>			
For cylinder Ø10		0,005	<b>P1A-2CCC</b>
For cylinder Ø12		0,005	<b>P1A-2DCC</b>
For cylinder Ø16		0,008	<b>P1A-2FCC</b>
For cylinder Ø20		0,008	<b>P1A-2HCC</b>
For cylinder Ø25		0,010	<b>P1A-2JCC</b>

### Electronic sensor symbol

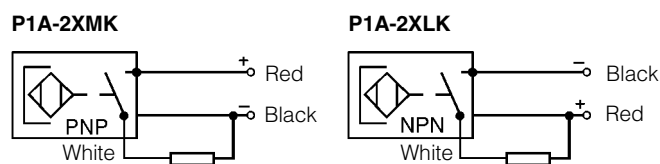

### Dimensions

#### P1A-2XMK and P1A-2XLK

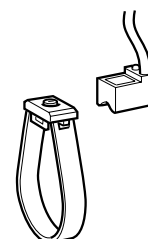
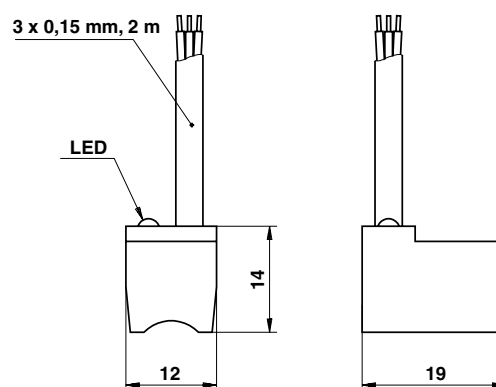

### Connecting cables with one connector

The cables have an integral snap-in female connector.



Type of cable	Cable/connector	Weight kg	Order code
<b>Cables for sensors, complete with one female connector</b>			
Cable, Flex PVC	3 m, 8 mm Snap-in connector	0,07	<b>9126344341</b>
Cable, Flex PVC	10 m, 8 mm Snap-in connector	0,21	<b>9126344342</b>
Cable, Super Flex PVC	3 m, 8 mm Snap-in connector	0,07	<b>9126344343</b>
Cable, Super Flex PVC	10 m, 8 mm Snap-in connector	0,21	<b>9126344344</b>
Cable, Polyurethane	3 m, 8 mm Snap-in connector	0,01	<b>9126344345</b>
Cable, Polyurethane	10 m, 8 mm Snap-in connector	0,20	<b>9126344346</b>
Cable, Polyurethane	5 m, M12 screw connector	0,07	<b>9126344348</b>
Cable, Polyurethane	10 m, M12 screw connector	0,20	<b>9126344349</b>

### Male connectors for connecting cables

Cable connectors for producing your own connecting cables. The connectors can be quickly attached to the cable without special tools. Only the outer sheath of the cable is removed. The connectors are available for M8 and M12 screw connectors and meet protection class IP 65.



Connector	Weight kg	Order code
M8 screw connector	0,017	<b>P8SCS0803J</b>
M12 screw connector	0,022	<b>P8SCS1204J</b>

### Ready to use connecting cables with connectors at each end

As accessories the system comprises a large number of different cables in order to meet all requirements that may arise and to make the installation simple, fast and reliable.

Cables with moulded 8 mm snap-in round contacts in both ends. The cables are available in two types, one with a straight male and female connectors respectively, and one with a straight 3-pole male connector in one end and an angled 3-pole female connector in the other end.



#### Technical data

##### Contacts

Moulded 8 mm snap-in male/female contacts.  
Enclosure IP67

##### Cable

Conductor 3x0,25 mm<sup>2</sup> (32x0,10 mm<sup>2</sup>)  
Sheath PVC/PUR  
Colour Black

Cables with straight 3-pole male and female connectors respectively.

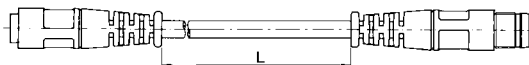

Cables with a straight 3-pole male connector in one end and an angled 3-pole female connector in the other end.



Designation	Weight kg	Order code
Cable with straight contacts, 0,2 m	0,02	<b>9121717014</b>
Cable with straight contacts, 0,3 m	0,02	<b>9121717015</b>
Cable with straight contacts, 0,5 m	0,03	<b>9121717016</b>
Cable with straight contacts, 1,0 m	0,03	<b>9121717017</b>
Cable with straight contacts, 2,0 m	0,05	<b>9121717018</b>
Cable with straight contacts, 3,0 m	0,07	<b>9121717019</b>
Cable with straight contacts, 5,0 m	0,12	<b>9121717020</b>
Cable with straight contacts, 10 m	0,23	<b>9121717021</b>

Designation	Weight kg	Order code
Cable with straight and angled connectors, 0,2 m	0,02	<b>9121717022</b>
Cable with straight and angled connectors, 0,3 m	0,02	<b>9121717023</b>
Cable with straight and angled connectors, 0,5 m	0,03	<b>9121717024</b>
Cable with straight and angled connectors, 1,0 m	0,03	<b>9121717025</b>
Cable with straight and angled connectors, 2,0 m	0,05	<b>9121717026</b>
Cable with straight and angled connectors, 3,0 m	0,07	<b>9121717027</b>
Cable with straight and angled connectors, 5,0 m	0,12	<b>9121717028</b>
Cable with straight and angled connectors, 10 m	0,23	<b>9121717029</b>

## Connection block Valvetronic 110

The Valvetronic 110 is a connection block that can be used for collecting signals from sensors at various points on a machine and connecting them to the control system via a multicore cable. Valvetronic 110 can also be used for central connection of the multi-core cable to the outputs of a control system, and can be laid to a machine where the output signals can be connected. The connection block has ten 8 mm snap-in circular connectors and a multi-core cable which is available in lengths of 3 or 10 m. The connections on the block are numbered from 1 to 10. Blanking plugs are available for unused connections, as labels for marking the connections of each block.



### Technical data

#### Connections:

Ten 3-pole numbered 8 mm round snap-in female contacts

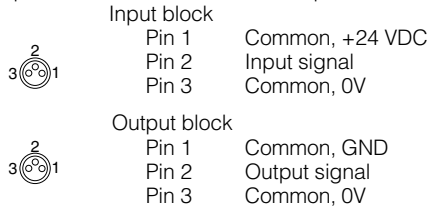

#### Electrical data:

Voltage: 24 VDC (max. 60 V AC/75 V DC)  
 Insulation group: according to DIN 0110 class C  
 Load: max. 1 A per connection total max. 3 A

#### Cable:

Length: 3 m or 10 m  
 Type of cable: LifyY11Y  
 Conductor: 12  
 Area: 0.34 mm<sup>2</sup>  
 Colour marking: According to DIN 47 100

#### Mechanical data

Enclosure: IP 67, DIN 40050 with fitted contacts and/or blanking plugs.  
 Temperature: -20 °C to +70 °C

#### Material

Body: PA 6,6 VD according to UL 94  
 Contact holder: PBTP  
 Snap-in ring: LDPE  
 Moulding mass: Epoxy  
 Seal: NBR  
 Screws: Plated steel

#### Industrial durability

Good chemical and oil resistance. Tests should be performed in aggressive environments.

### Ordering data

Designation	Weight kg	Order code
Connection block Valvetronic 110 with 3 m cable	0,32	<b>9121719001</b>
Connection block Valvetronic 110 with 10 m cable	0,95	<b>9121719002</b>
Blanking plugs (pack of 10) Use blanking plugs to close unused connections.	0,02	<b>9121719003</b>
Labels (pack of 10) White labels to insert in grooves on the side of the connection	0,02	<b>9121719004</b>

### Dimensions and wiring diagrams

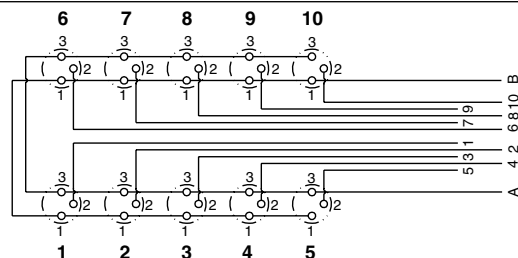
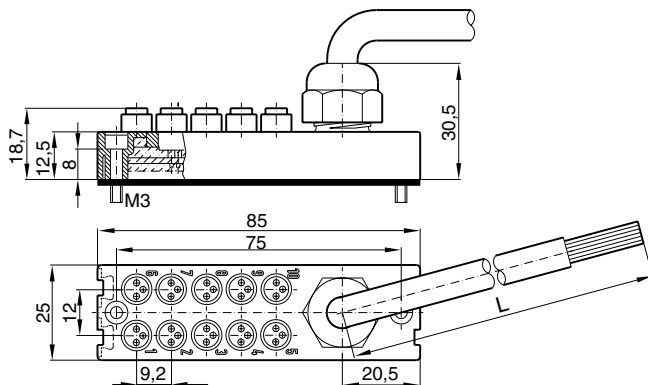

Conductor Colour	Input	Output
1 Pink	Signal 1	Signal 1
2 Grey	Signal 2	Signal 2
3 Yellow	Signal 3	Signal 3
4 Green	Signal 4	Signal 4
5 White	Signal 5	Signal 5
6 Red	Signal 6	Signal 6
7 Black	Signal 7	Signal 7
8 Violet	Signal 8	Signal 8
9 Grey-Pink	Signal 9	Signal 9
10 Red-Blue	Signal 10	Signal 10
A Blue	0 V	0 V
B Brown	+24 V	PE

**www.parker.com**

## **Pneumatic Division Sales Offices**

---

**Austria - Wr.Neustadt**  
Tel: +43 2622 23501  
Fax: +43 2622 66212

**Norway - Langhus**  
Tel: +47 6491 1000  
Fax: +47 6491 1090

**Belgium - Nivelles**  
Tel: +32 67 280 900  
Fax: +32 67 280 999

**Poland - Warsaw**  
Tel: +48 22 573 24 00  
Fax: +48 22 573 24 03

**Czech & Slovak  
Republics - Klecany**  
Tel: +420 284 083 111  
Fax: +420 284 083 112

**Portugal - Leça da  
Palmeira**  
Tel: +351 22 999 7360  
Fax: +351 22 996 1527

**Denmark - Ballerup**  
Tel: +45 43 560400  
Fax: +45 43 733107

**Romania - Bucharest**  
Tel: +40 21 252 1382  
Fax: +40 21 252 3381

**Finland - Vantaa**  
Tel: +358 9 4767 31  
Fax: +358 9 4767 3200

**Russia - Moscow**  
Tel: +7 095 234 0054  
Fax: +7 095 234 0528

**France - Contamine**  
Tel : +33 4 50 25 80 25  
Fax : +33 4 50 03 67 37

**Slovenia - Novo mesto**  
Tel: +386 7337 6650  
Fax: +386 7337 6651

**Germany - Kaarst**  
Tel: +49 2131 4016-0  
Fax: +49 2131 4016-9199

**Spain - Madrid**  
Tel: +34 91 675 7300  
Fax: +34 91 675 7711

**Greece - Athens**  
Tel: +30 210 933 6450  
Fax: +30 210 933 6451

**Sweden - Spånga**  
Tel: +46 (0) 8 5979 5000  
Fax: +46 (0) 8 5979 5120

**Hungary - Budapest**  
Tel: +36 1 220 4155  
Fax: +36 1 422 1525

**Switzerland - Bolligen**  
Tel: +41 31 917 18 50  
Fax: +41 31 917 18 59

**Ireland - Dublin**  
Tel: +353 1 293 9999  
Fax: +353 1 293 9999

**Turkey - Istanbul**  
Tel: +90 212 482 91 06  
Fax: +90 212 482 91 10

**Italy - Corsico, Milan**  
Tel: +39 02 4519 21  
Fax: +39 02 4479 340

**UK - Warwick**  
Tel: +44 1926 317 878  
Fax: +44 1926 317 855

**Netherlands - Oldenzaal**  
Tel: +31 541 585000  
Fax: +31 541 585459

**Ukraine - Kiev**  
Tel: + 380 44 220 7432  
Fax: + 380 44 220 6534



**Parker Hannifin plc**  
Pneumatic Division,  
Walkmill Lane, Bridgtown,  
Cannock, Staffs. WS11 0LR  
United Kingdom

We reserve the right to make  
alterations without prior notification.  
Edition 06.01