



aerospace
climate control
electromechanical
filtration
fluid & gas handling
hydraulics
pneumatics
process control
sealing & shielding



Compax3

Compax3 Intelligent Servo Drive



ENGINEERING YOUR SUCCESS.



WARNING – USER RESPONSIBILITY

FAILURE OR IMPROPER SELECTION OR IMPROPER USE OF THE PRODUCTS DESCRIBED HEREIN OR RELATED ITEMS CAN CAUSE DEATH, PERSONAL INJURY AND PROPERTY DAMAGE.

- This document and other information from Parker-Hannifin Corporation, its subsidiaries and authorized distributors provide product or system options for further investigation by users having technical expertise.
- The user, through its own analysis and testing, is solely responsible for making the final selection of the system and components and assuring that all performance, endurance, maintenance, safety and warning requirements of the application are met. The user must analyze all aspects of the application, follow applicable industry standards, and follow the information concerning the product in the current product catalog and in any other materials provided from Parker or its subsidiaries or authorized distributors.
- To the extent that Parker or its subsidiaries or authorized distributors provide component or system options based upon data or specifications provided by the user, the user is responsible for determining that such data and specifications are suitable and sufficient for all applications and reasonably foreseeable uses of the components or systems.

Overview	5
System Layout	6
Innovative, Flexible Device Technology	8
Control Technology	10
Safety Technology	11
Device Technologies	12
Compax3F: Hydraulics Controller	18
Technical Characteristics.....	19
Technical Data	19
Safety Technology	20
Positioning	20
Supported Motor and Feedback Systems	21
Ambient Conditions	21
Ports	22
Standards and Conformance	22
Dimensions	23
Accessories and Options	24
Software and Tools	24
Programming	24
Signal Analysis for the System Identification	25
Order Code.....	26
Devices: Compax3	26
Accessories	27

Parker Hannifin

The global leader in motion and control technologies

A world class player on a local stage

Global Product Design

Parker Hannifin has more than 40 years experience in the design and manufacturing of drives, controls, motors and mechanical products. With dedicated global product development teams, Parker draws on industry-leading technological leadership and experience from engineering teams in Europe, North America and Asia.

Local Application Expertise

Parker has local engineering resources committed to adapting and applying our current products and technologies to best fit our customers' needs.

Manufacturing to Meet Our Customers' Needs

Parker is committed to meeting the increasing service demands that our customers require to succeed in the global industrial market. Parker's manufacturing teams seek continuous improvement through the implementation of lean manufacturing methods throughout the process. We measure ourselves on meeting our customers' expectations of quality and delivery, not just our own. In order to meet these expectations, Parker operates and continues to invest in our manufacturing facilities in Europe, North America and Asia.

Electromechanical Worldwide Manufacturing Locations

Europe

Littlehampton, United Kingdom
Dijon, France
Offenburg, Germany
Filderstadt, Germany
Milan, Italy

Asia

Wuxi, China
Jangan, Korea
Chennai, India

North America

Rohnert Park, California
Irwin, Pennsylvania
Charlotte, North Carolina
New Ulm, Minnesota



Offenburg, Germany

Local Manufacturing and Support in Europe

Parker provides sales assistance and local technical support through a network of dedicated sales teams and authorized technical distributors throughout Europe.

For contact information, please refer to the Sales Offices on the back cover of this document or visit www.parker.com



Milan, Italy



Littlehampton, UK



Filderstadt, Germany



Dijon, France

Intelligent Servo Drive Compax3

Overview

Description

Compax3 is Parker Hannifin's global servo drive. The drive series includes single and multi axis drives as well as hydraulic controllers. It features a power range from 1 to 109 kVA.

The servo drives are completely developed and manufactured in Germany. An additional Compax3 production site was established in the US. As a global servo drive controller, Compax3 is of course available all over the world. Service and support sites are located in the vicinity of all major industry locations - worldwide. The "Parker Authorized Distribution Partners" do play an important role in this context - well-trained and experienced application and support specialists will provide the necessary professional support in any situation.



Features

Hardware

- Power range from 1 to 109 kW
- 1 encoder output / 1 encoder input
- 8 digitale inputs / 4 digital outputs
- 2 analog inputs (14 Bit)
- 2 analog outputs (8 Bit)
- Several fieldbuses
- Extensive safety technology

Technology Functions

- I10T10: Drive control via: velocity/torque control, step/direction input, encoder input
- I12T11: Positioning via digital I/Os, RS232/RS485, absolute/relative positioning, registration mark related positioning, electronic gearbox, dynamic positioning
- T30: Programming based on IEC61131-3 with CoDeSys
 - PLCopen function modules
 - IEC61131-3 - standard modules
 - C3-specific function modules
- T40: T30 functionality + cam function

Technical Characteristics - Overview

Device:	Current [A]		Supply voltage	Power [kVA]
	I _{cont.}	I _{peak} (<5 s)		
Compax3				
S025V2	2.5	5.5	1 *	1.0
S063V2	6.3	12.6	230/240 VAC	2.5
S100V2	10	20	3 *	4.0
S150V2	15	30	230/240 VAC	6.0
S015V4	1.5	4.5	3 * 400/480 VAC	1.25
S038V4	3.8	9.0		3.1
S075V4	7.5	15		6.2
S150V4	15	30		11.5
S300V4 ⁽¹⁾	30	60		25.0
H050V4	50	75	3 * 400/480 VAC	35.0
H090V4	90	135		70.0
H125V4	125	187.5		91.0
H155V4	155	232.5		109.0

⁽¹⁾ Operation with capacitor module ModulC4.

Device:	Current [A]		DC bus voltage
	I _{cont.}	I _{peak} (<5 s)	
Compax3			
M050D6	5	10	325...679 VDC (Rated voltage 560 VDC)
M100D6	10	20	
M150D6	15	30	
M300D6	30	60	

System Layout

Ethernet



XPR



Parker Automation Controller

Communication channel



Compax3S
High Performance
Servo Drive



Compax3M
Multi Axis
Servo Drive



Synchronous Servo Motors



Precision Actuators



Handling Actuators



Compax3H
High Power
High Performance
Servo Drive



Compax3F
High Performance
Hydraulics
Controller

Parker Automation Tools

IEC 61131-3
PLCopen
Data handling
Visualization
Communication (Process Control)
Access to all components
Project management

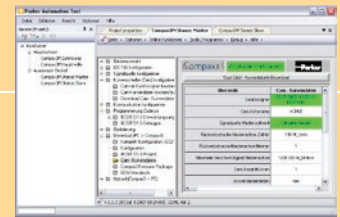

Communication
Multi-axis tool
C3 ServoManager
Drive Interface

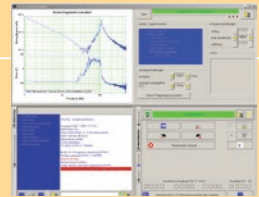

IEC 61131-3
PLCopen
CamDesigner
Optimization
Setup
Diagnosis / Analysis / Maintenance
Oscilloscope



MotorManager
Motor library
Actuator library
HydraulicsManager
Valve library



Sizing Tool
SERVOsoft® (available on request)

PC Software

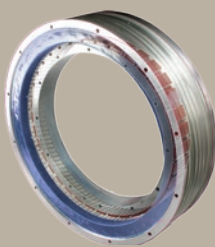

Direct drives

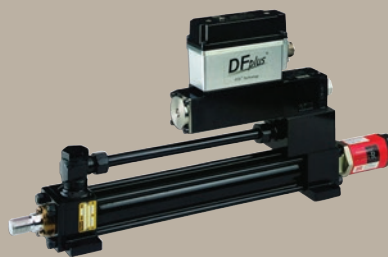

Hydraulics Components

Innovative, Flexible Device Technology

The development of Compax3 was focused on maximum openness and flexibility for a wide variety of applications.

Motors / Actuators

Today, motors and actuators are available in many different versions and technologies. The Compax3 servo drives support most common motors. Among these are:

- Sine commutated synchronous and asynchronous motors
- Direct drives
 - Torque Motors
 - Linear servo motors



Feedback Systems

In this context, the Compax3 servo drives support the following feedback systems:

- Resolver
- Sine - Cosine Feedback (Single or Multiturn)
 - Hiperface interface
 - Optical and capacitive sensors
- EnDat Interface
- Analog and digital Hall sensors
- Rotary and Linear Encoders
 - Distance coded
 - Incremental and RS422
 - EnDat Interface

Control Technology

The drive controller's modern control technology with automatic load identification / self control as well as an observer function which can be optionally activated is a guarantor of optimized motion control under all conditions.

Communication

The support of all common Fieldbus interfaces is an essential feature of open systems. Among these are Profibus, CANopen, DeviceNet as well as the modern Ethernet based interfaces such as EtherCAT, PROFINET and Powerlink interfaces. The open OPC communication standard simplifies system integration considerably.

For dynamic, multi axis synchronized applications, a real-time drive bus is available for all drives from the Compax3 family.



Software / Tools

Simple and efficient use of a modern and complex automation component offering high functionality such as Compax3 is guaranteed by an intuitively operable software tool. The specially designed "Parker Integrated Engineering Tool". Integral components of this software package are:

- Multi axis system management
- ServoManager
- MotorManager
- ActuatorManager
- HydraulicsManager
- CamDesigner
- IEC 61131-3 / CoDeSys – programming environment
- IEC 61131-3 – Debugger

This software tool supports the user in the configuration, the setup and optimization, the programming as well as the maintenance of all Compax3 devices. ("Software and Tools" see page 24)



System Solutions

The Compax3 series servo drives represent an important component for the design of complete automation systems. The user can choose between additional components optimally suited for the use with Compax3.

Among those are:

- Operating and observing - XPR operator panels for all graphics and text applications
- Service and maintenance - BDM plug-in module
 - Change of parameters
 - Manual mode
 - Device exchange without PC
- Extension modules for the field level - external devices for digital and analog signal acquisition and control

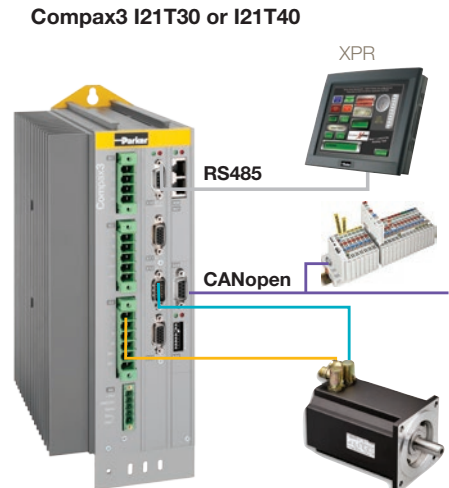

Electromechanical overall solutions

Electromechanical system solutions play a special role today. Parker Hannifin is not only the manufacturer of modern drive and control technology, but also of

- Handling technology
- Precision Mechanics

As a special service we offer our customers complete, ready-to-mount electromechanic solutions, especially developed and manufactured for special industries or individual customers. In many cases, this reduces the development overhead on the user side considerably.

Thousands of systems installed prove Parker Hannifin's as well as their partner's - the "Parker Automation Technology Centers" - high competence and long experience.

Prefabricated integrated technology functions support the user's tasks. Furthermore, you can extend these functions by your own know-how at any time.

Quality

Our customer systems must meet the highest demands with respect to resilience. Compax3 by Parker Hannifin exceeds by far the high quality requirements for an automation component. Not only the quality characteristics but also our customers speak volumes.

Safety

With many applications in harsh and arduous environments such as presses and robot cells, Parker ensures that product and system reliability and quality are second to none. Drive integrated systems as implemented in Compax3 support the machine designer in realizing safe and cost-efficient solutions.

Control Technology

Real-time signal processing

- Reduction of the quantization noise
- Increase of the signal resolution
 - Due to oversampling of the speed and current signals
- Online feedback error compensation of offset and gain errors
- 14 Bit resolution increase (Increase of the resolution of the scale graduation of up to 14 Bit)
 - By interpolation of sine-cosine feedback signals
- Determination of the speed by the observer technique
- Doubling of the controller bandwidth
 - By load torque observer principle

Jerk-limited setpoint generation, resulting in:

- Gentle handling of the moved goods
- Increased service life of mechanical components
- Overshoot free positioning
- Reduced excitation for mechanical resonance frequencies

Control:

- Controller in the feedback path helps avoid differentiating components in the numerator of the transmission function (which will result in a significant overshoot of the actual value)
- Automatic and robust controller design
 - User-oriented optimization parameters "damping" and "stiffness"
- Optimization of the response behavior
- Minimization of the following error
 - Due to feedforward of speed, acceleration, motor current and jerk
- Dual Loop Option
 - The load control can be activated via an additional feedback system for the acquisition of the actual position of the load.

Commissioning / controller optimization

- Automatic determination of the load moment of inertia
- Compax3 MotorManager for determining the motor characteristics and the motor position feedback
- Optimization with integrated oscilloscope function

Signal resolution

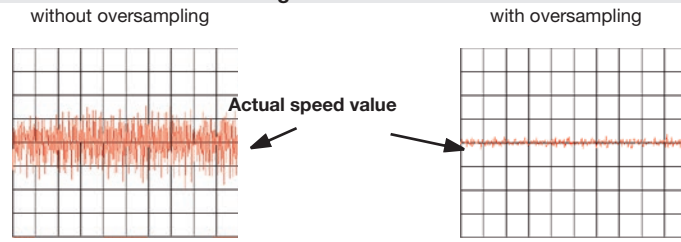

Online feedback error compensation

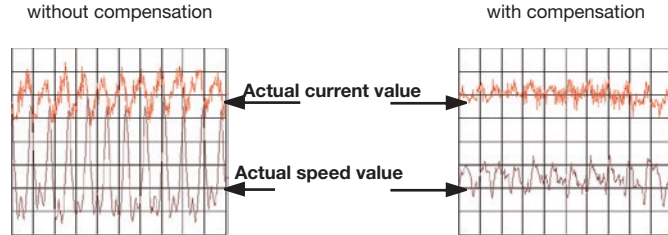

- 1: Position
- 2: Speed
- 3: Acceleration
- 4: Jerk

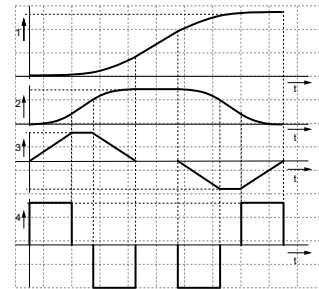

Effect of the feedforward measures using the jerk feedforward as an example

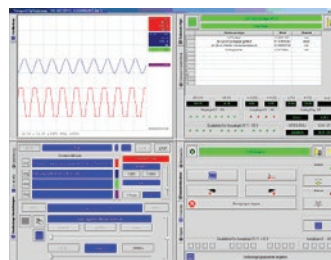
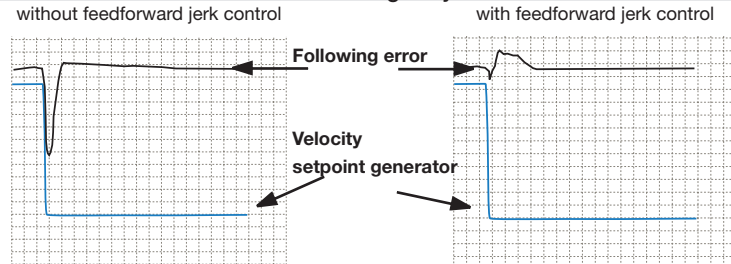

Safety Technology

Integrated Safety in the Compax3

In addition to the typical tasks of motion control, a modern drive controller must also be able to perform relevant safety tasks in order to comply with the requirements of the new machinery directive 2006/42/EG. Thanks to the integrated STO - "Safe Torque OFF" safety function, you will save space and money for external power relays. It also reduces error-prone external wiring.

STO is today offered as a standard integrated into the Compax3 family servo drives. Furthermore, the Compax3M multi-axis servo drive is able to offer additional sophisticated safety functions with the aid of option card S3. For details, please see "Technical Data" "Safety technology" (page 20)

Compax3M Series Servo Drives with integrated Safety Technology as an option

Compax3 Series servo drives offer the STO (Safe Torque Off) function which helps to implement important functions, such as protection against unexpected start up as a standard. In many cases, the basic STO (Safe Torque Off) function is however no longer sufficient, as setup is frequently required while the machine is powered. For these applications, Compax3M offers option card S3, which provides the following functions in accordance with EN61800-5-2:

- SS1 - Safe Stop 1
- SS2 - Safe Stop 2
- SOS - safe operating stop
- SLS – Safely Limited Speed
- SLP - Safely Limited Position
- SLI – Safely Limited Increment
- SDI – Safe Direction
- SSM - Safe Speed Monitor (Diagnostics output for SLS)

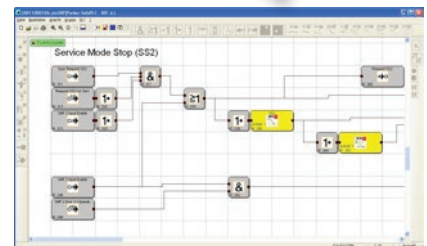

Programming and validation of the safe motion functions takes place with the aid of the SafePLC safety editor, which is integrated in the Compax3 ServoManager.

Increased productivity thanks to drive integrated safety technology

Hazard: Setup

Measures:

Safely limited speed (SLS)

The "safely limited speed" function monitors that the drive keeps a defined maximum speed. If the speed limit value is exceeded, the drive is safely switched off.

Safe direction (SDI)

The "safe direction" function ensures that the motion of a drive can only be in one (defined) direction. If the defined motion direction is not respected, the drive is safely switched off.

Advantages

Safe working while the protection grids are open will:

- Reduced changeover times due to a better insight into the changeover zone
- Increased working safety by guaranteeing the direction of motion as selected by jog function
- Increased working safety thanks to safely limited setup speed

Hazard: Intervention into the process

Measures:

Safe operating stop (SOS)

The "safe operating stop" function monitors the attained stop position of the axis and prevents that the position window is left. The control functions of the drive remain completely active. If the position window monitored is left, the drive is safely switched off.

Safe Stop 2 (SS2)

With the "Safe Stop 2" function, the drive is shut down in a controlled manner, after that, the "safe operating stop" is introduced. In the "safe operating stop", the control functions of the drive remain completely active.

Advantages

Safe Operating Stop, (SOS and SS2) results in increased productivity due to:

- Axis synchronicity being maintained
- Quick and easy re-startup of the system
- Increased safety thanks to protection against unwanted startup of the system

Device Technologies

Compax3 I10T10: Step/Direction and Analog Command Input I10T10 Scope of Functions

With its analogue interface or alternatively with step/direction or encoder step signals, the Compax3 I10T10 gives you easy and reasonably priced access to the world of servo-drive technology. Irrelevant of whether you have a PLC or PC central control unit, this remains unchanged.

The Compax3 I10T10 represents an ideal way of migrating from analog ± 10 V drives to digital, intelligent servo-drives.

You can choose between the different operating modes:

± 10 V Input

- ± 10 V predefined speed with encoder simulation as actual value feedback
- ± 10 V predefined current setpoint with encoder emulation for actual position value feedback and configurable holding functions
- Zero pulse of the emulation within a motor revolution can be freely selected

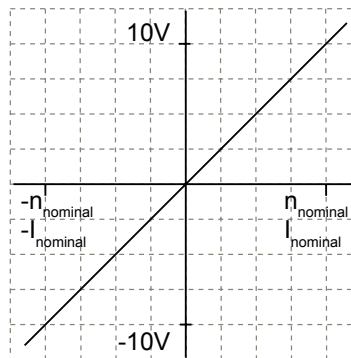

Step/Direction Command Input

- Step/direction signals as 24 V logic levels or
- With step/direction logic signals conforming to RS422

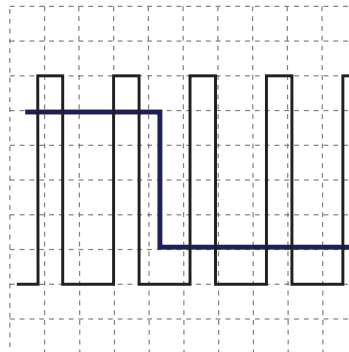

Encoder Input

- RS422
- 24 V level

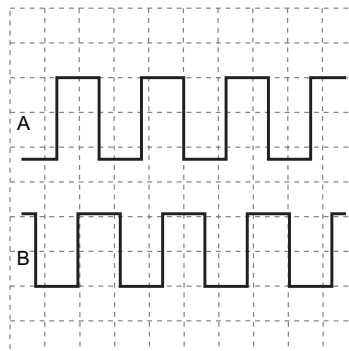

Compax3 T11: Positioning

T11 Scope of Functions

Due to its high functionality, the Positioning version of Compax3 forms an ideal basis for many applications in high-performance motion automation.

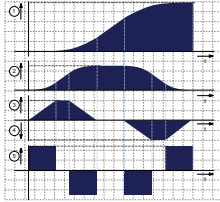

- Up to 31 motion profiles can be created with the help of the PC software:
 - Absolute or relative positioning
 - Electronic Gearbox (Gearing)
 - Reg-related positioning
 - Speed control
 - Stop - Set
- Dynamic positioning
- Movement profiles in non-volatile flash
- Motion profiles can be selected via field bus or digital inputs/outputs
- Wide choice of machine zero modes for your individual application
- Detection of the absolute position by distance-coded feedback
- Easy commissioning
 - Guided configuration with the Compax3 ServoManager
 - Flexible Optimization
- Adjustable jerk limitation
- Optional extension of the digital I/Os

Compax3 I12T11 / Motion Control:

- Via digital I/Os
- Via RS232 / RS485 with the aid of control & status word
- Up to 31 motion functions via set table
- Status bits for each motion set

Access via Compax3 inputs and outputs:

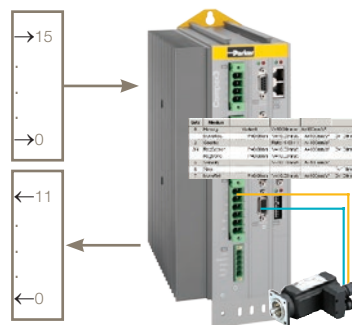

Access via RS232 / RS485:

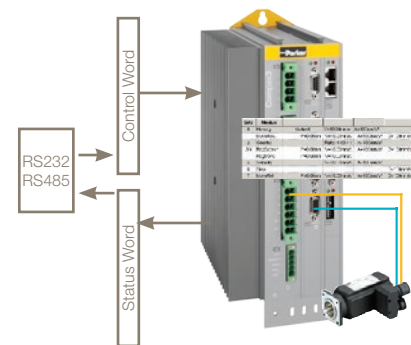

Compax3 I2xT11 / I3xT11 Motion Control:

- Standard profiles via PROFIBUS, PROFINET, CANopen, DeviceNet, Ethernet Powerlink and EtherCAT
- Direct set specification via fieldbus telegrams or
- Set selection (31 motion sets)
- Status bits for each motion set
- Operating modes:
 - Speed controller, direct positioning, positioning via set selection

Characteristics:

PROFIBUS	
Profile:	PROFIdrive Profile drive system V3
DP versions:	DPV0/DPV1
Baud rate:	up to 12 Mbit/s
PROFINET	
Profile:	PROFIdrive profile drive technology V4.1
Version:	PROFINET IO (RT)
Transmission mode:	100BASE-TX (Full Duplex)
CANopen	
Profile:	MotionControl CiADS402
Baud rate:	20...1000 Kbit/s
DeviceNet	
I/O Data:	up to 32 bytes
Baud rate:	125...500 Kbit/s
Nodes:	up to 63 slaves
Ethernet Powerlink	
Profile:	MotionControl CiADS402
Baud rate:	100 Mbit/s (FastEthernet)
Cycle time:	from 500 µs
EtherCAT	
Profile:	MotionControl CiADS402
Baud rate:	100 Mbit/s (FastEthernet)
Cycle time:	from 125 µs

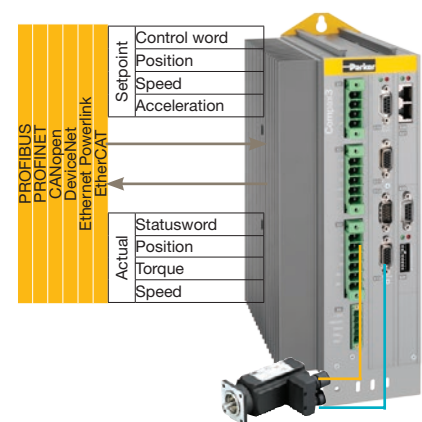

Motion Function:

Absolute / Relative Positioning:
MoveAbs and MoveRel

- A motion set defines a complete motion with all settable parameters.
 - (1) Target position
 - (2) Travel speed
 - (3) Maximum Acceleration
 - (4) Maximum deceleration
 - (5) Maximum Jerk

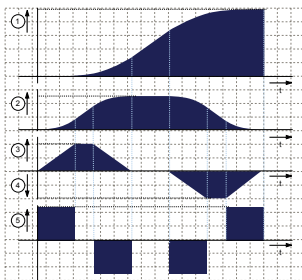

Reg-related positioning:
RegSearch, RegMove

- For registration mark-related positioning, 2 motions are defined.
 - RegSearch: Search of an external signal - a reg; e.g. a mark on a product
 - RegMove: The external signal interrupts the search movement and the second movement by an offset follows without transition
- Accuracy of the reg detection: <math><1 \mu s</math>

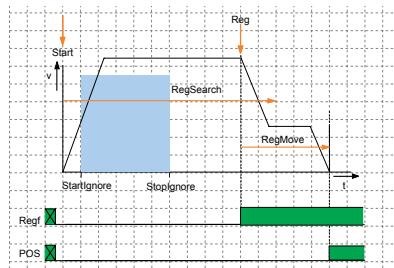

Electronic Gearbox:
Gearing

- Synchronous motion to a leading axis with any transmission ratio. The position of a master axis can be detected via:
 - +/-10 V analog input
 - Step / direction input
 - the encoder input or
 - HEDA, with Compax3 master

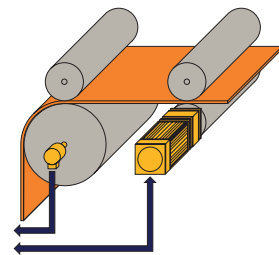

Dynamic positioning

- You can switch to a new motion profile during a positioning sequence - a dynamic transition takes place.

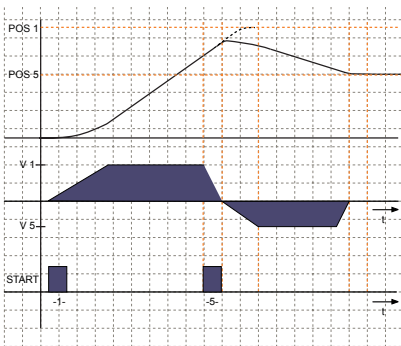

Speed control:
Velocity

- Defined via speed and acceleration.

Stop movement:
Stop

- The Stop set interrupts the current motion set.

2/3 Satztafel

Satz	Modus					
0	Homing	Mode=0	V=10.00mm/s	A=100mm/s²		000
1	MoveAbs	P=10.00mm	V=10.00mm/s	A=100mm/s²	D=100mm/s²	J=1000000mm/s³
2	Velocity		V=30.00mm/s	A=100mm/s²		XXX
3	Gearing		Ratio=0.25 / 1	A=100mm/s²		XXX
4	Stop				D=100mm/s²	J=1000000mm/s³
5/6	RegSearch	P=50.00mm	V=10.00mm/s	A=100mm/s²	D=100mm/s²	J=1000000mm/s³
	RegMove	P=60.00mm	V=10.00mm/s	A=100mm/s²		XXX
7	MoveRel	P=-100.00mm	V=10.00mm/s	A=100mm/s²	D=100mm/s²	J=1000000mm/s³
8	Gearing		Ratio=0.33 / 1	A=100mm/s²		XXX
9	MoveAbs	P=20.00mm	V=10.00mm/s	A=100mm/s²	D=100mm/s²	J=1000000mm/s³
10	Stop				D=100mm/s²	J=1000000mm/s³
11	MoveAbs	P=40.00mm	V=10.00mm/s	A=100mm/s²	D=100mm/s²	J=1000000mm/s³
12/13	RegSearch	P=100.00mm	V=10.00mm/s	A=100mm/s²	D=100mm/s²	J=1000000mm/s³
	RegMove	P=0.00mm	V=10.00mm/s	A=100mm/s²		111
14	MoveRel	P=-40.00mm	V=10.00mm/s	A=100mm/s²	D=100mm/s²	J=1000000mm/s³
15	Stop				D=100mm/s²	J=1000000mm/s³
16	Velocity		V=25.00mm/s	A=100mm/s²		XXX
17	Gearing		Ratio=1.00 / 1	A=100mm/s²		XXX
18/19	RegSearch	P=70.00mm	V=10.00mm/s	A=100mm/s²	D=100mm/s²	J=1000000mm/s³
	RegMove	P=0.00mm	V=10.00mm/s	A=100mm/s²		1XX
20	MoveAbs	P=0.00mm	V=10.00mm/s	A=100mm/s²	D=100mm/s²	J=1000000mm/s³
21	Gearing		Ratio=0.13 / 1	A=100mm/s²		XXX
22	MoveAbs	P=0.00mm	V=10.00mm/s	A=100mm/s²	D=100mm/s²	J=1000000mm/s³
23	Stop				D=100mm/s²	J=1000000mm/s³
24	Empty					mm

Entry of motion sets

Compax3 T30: IIEC 61131-3 Positioning with function modules based on PLCopen

T30 Scope of Functions

- Programming in accordance with IEC 61131-3
- Programming system: CoDeSys
- up to 6000 instructions
- 650 16bit variables / 200 32bit variables
- Recipe table with 288 variables
- 3 16-bit retain variables / 3 32-bit retain variables
- Inputs/outputs:
 - 8 digital inputs (24 V level)
 - 4 digital outputs (24 V level)
 - 2 analog inputs (14 Bit)
 - Optional extension of 12 inputs/ outputs
- IEC 61131-3 standard modules:
 - Up to 8 timers (TON, TOF, TP)
 - Triggers (R_TRIG, F_TRIG)
 - Flip-flops (RS, SR)
 - Counters (CTU, CTD, CTUD)
- Device-specific function modules:
 - C3_Input: Generates an input process image
 - C3_Output: Generates an output process image
 - C3_ReadArray: Access to recipe table
 - Force control on request
- PLCopen function modules:
 - Positioning: absolute, relative, additive, continuous
 - Machine Zero
 - Stop, energizing the power stage, Quit
 - Position, device status, reading axis error
 - Electronic gearbox (MC_GearIn)



Compax3 Function Blocks

- Absolute Positioning
- Stop
- Reading axis error
- Relative Positioning
- Machine Zero
- Acknowledging errors
- Additive positioning
- Energizing the power stage
- Reading the current position
- Continuous positioning
- Reading device status
- Electronic Gearbox (Gearing)

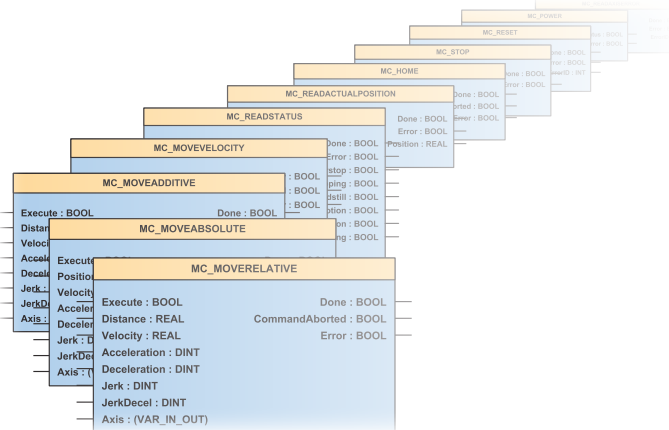

Example of an IEC 61131 application controlled by means of a bus interface:

- 2 control words are placed on the cyclic channel of the bus.
- The position data records (position, speed, acceleration, ... are stored in a table (array).
- The desired position data record is selected with Controlword_2.
- The individual bits of Controlword_1 control positioning.
- A return message is given through a status word on the cyclic channel of the bus.

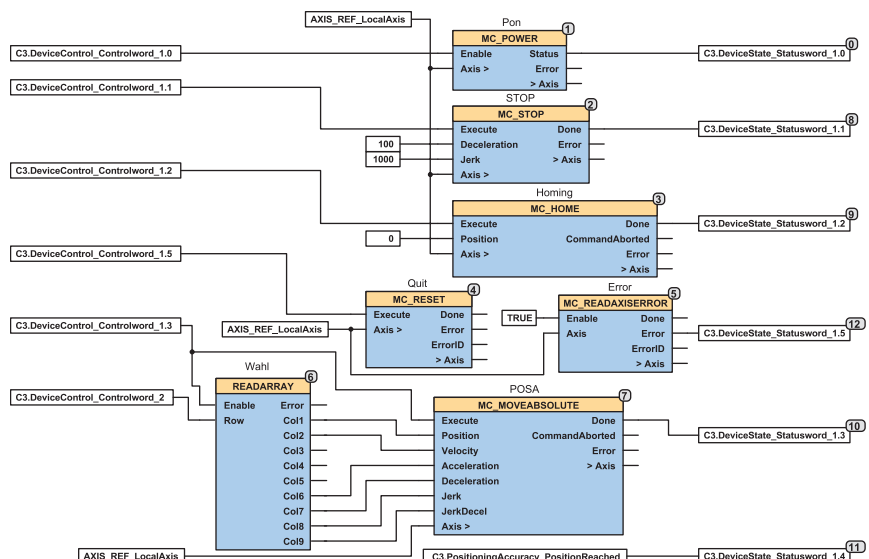

Compax3 T40: IEC 61131-3 positioning with cam function modules

T40 Scope of Functions:

Compax3 T40 is able to simulate mechanical cams and cam switching mechanisms electronically. The “Electronic Cam - T40 was especially optimized for

- Packaging Machinery,
- Printing Industry as well as
- all applications where a mechanical cam is to be replaced by a flexible, cyclic electronic solution.

This helps to realize discontinuous material supply, flying knife and similar drive applications with

distributed drive performance. Compax3 T40 supports both real and virtual master movements. In addition, the user can switch to other cam profiles or cam segments on the fly. Programming is carried out in the IEC 61131-3 environment. Cam applications can be easily implemented with the aid of the cam function modules and the CamDesigner.

T40 Function Overview:

- T30 Technology Functions completely integrated and available
- Master position acquisition
- Reg synchronization
- Electronic Cam switches
- Coupling and decoupling functions
- Cam profiles
- Cam memory
- Cam creation with the CamDesigner

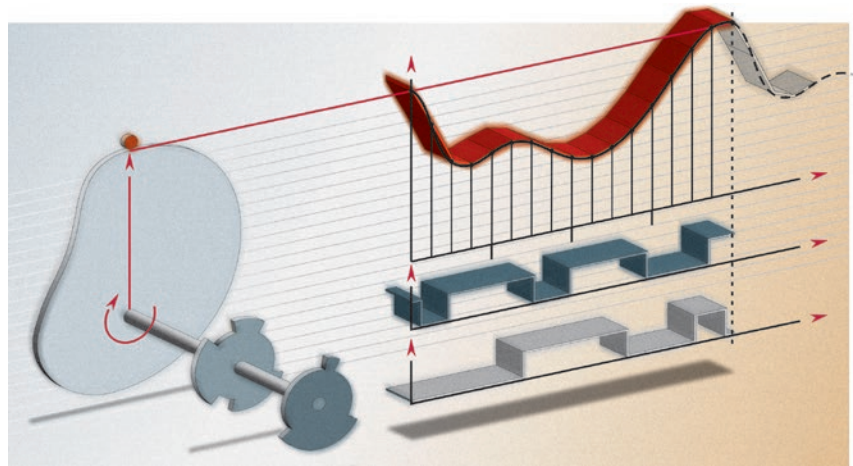

Cutting on the fly

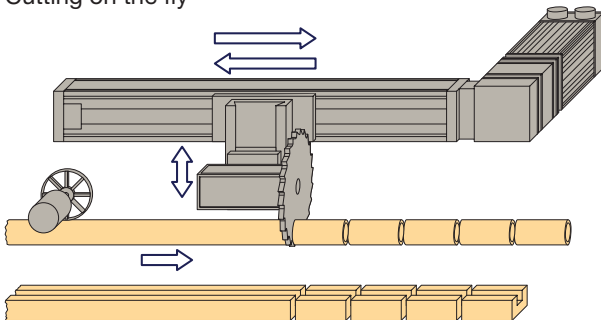

Diagonal-beam sawing

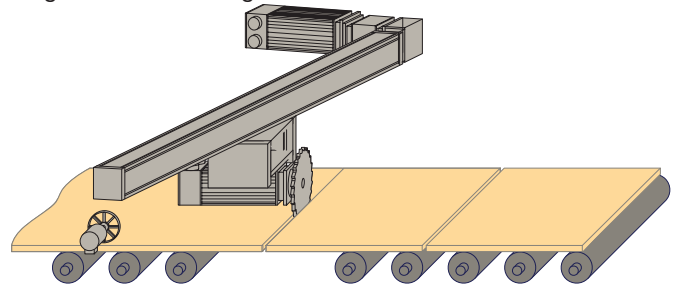

Machining during motion

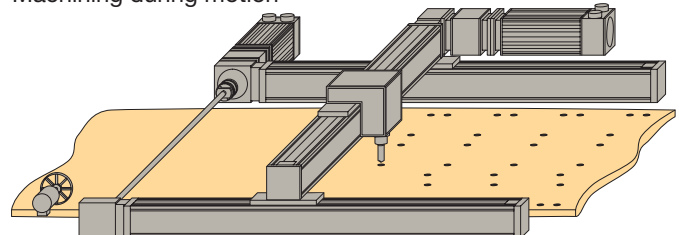

Master Position Acquisition

- Acquisition via SSI encoder or incremental encoder
- Acquisition by the HEDA real-time bus
- Virtual master:
 - A second axis in the IEC - program can be used to program a motion profile which serves as a master for one or several slaves

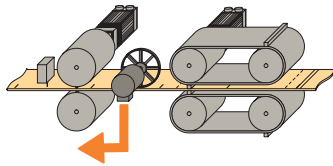

Reg Synchronization

- Master or slave oriented (simultaneous, cam-independent)
- Highly precise reg mark recognition (accuracy < 1 μ s; Touchprobe)

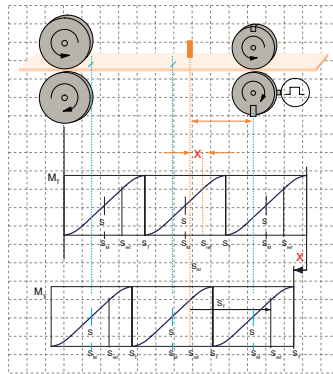

Cam Memory

- 10000 points (master / slave) in 24 bit format
- High-precision profile generation:
 - Non equidistant interpolation points of the master and slave coordinates (stored fail-safe)
 - Linear interpolation between interpolation points
- Cam memory for up to 20 curves

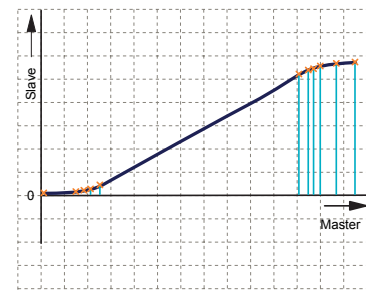

Coupling and Decoupling Functions

- By means of a setpoint generator
- By means of a change-over function
- Without overspeeding by coupling over several master cycles
- Virtually free set-up of the coupling and decoupling movement
- Master-guided coupling movement
- Random standstill position

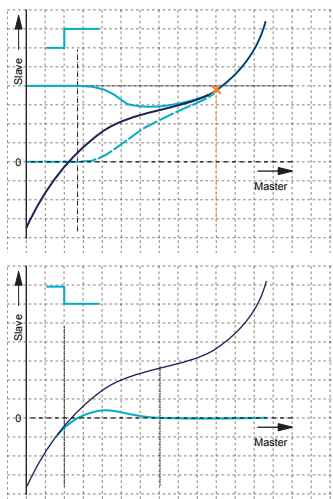

Cam Profiles

- Up to 20 cam segments can be produced by:
 - Virtually random cam links (forwards and backwards)
 - Freely programmable event-controlled cam branches
 - Scalable cam segments and complete cam profiles

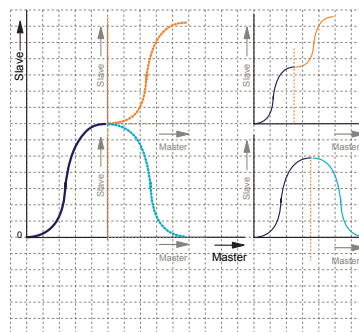

Cam Controller

- 36 cams with individual profiles.
- 4 fast cams (125 μ s per cam) standard: 500 μ s.
- 32 serial cams, 16 ms/cam cycle (0.5 ms/cam).
- Delay-time compensated cams: Compax3 can advance the cam to compensate for delays in switching elements.

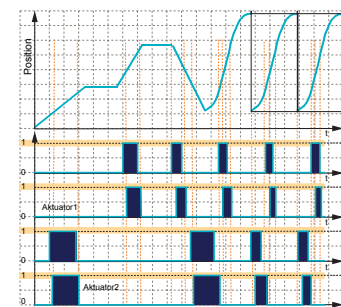

Compax3F: Hydraulics Controller

The Compax3F hydraulics controller is another member of the Compax3 family based on the well-known Compax3 digital drive. Thus, all advantages offered by the Compax3 family are now also available in servo- and proportional hydraulics. The hydraulics controller is available with the following technologies:

Technology Functions

- T11: Positioning
- T30: Motion control programmable in accordance with IEC 61131-3
- T40: Electronic cam

Communication

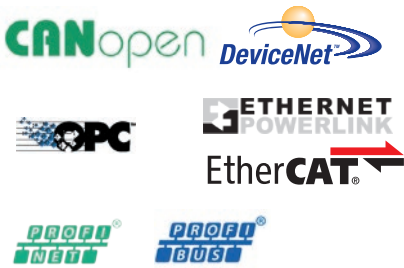

PROFIBUS and PROFINET are registered trademarks of PROFIBUS & PROFINET International (PI). EtherCAT® is a registered trademark and patented technology, licensed by Beckhoff Automation GmbH, Germany.

Your Advantage:

- It is no longer necessary to distinct between the motion of a hydraulic or an electromechanical axis on the control technology level .
- Common software tools for electromechanics and hydraulics supporting the design of hybrid machines.

Especially the combination with the highly dynamic DFplus valve can be used to efficiently increase your machine performance.

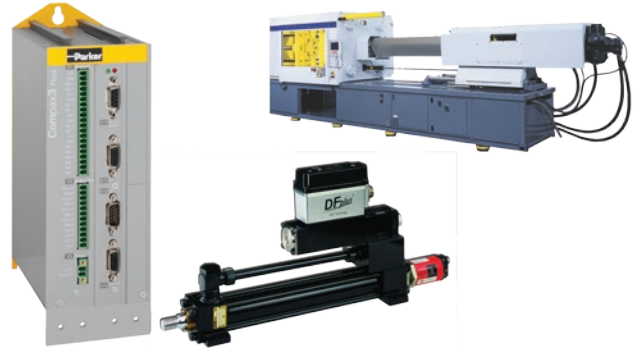

Device:	Compax3 F001 D2 F12 Ixx Txx Mxx
Power Supply	
Voltage Operating Range	21-27 VDC
Inputs and outputs	
8 control inputs	24 VDC / 10 kOhm
4 control outputs	Active HIGH / short-circuit proof / 24 V / 100 mA
4 analog current inputs	14 Bits
2 analog voltage inputs	14 Bits
4 analog outputs	16 Bits, current or voltage
2 analog monitor outputs	8 bits
Communication	
RS232	115200 Bauds
RS485 (2 or 4-wire)	9600, 19200, 38400, 57600 or 115200 Bauds
...	
Feedback	
	1 V _{PP} SineCosine (max. 400 Hz) RS422 Encoder (max. 5 MHz, or Step/Direction) SSI (RS422) Start / Stop (Time of Flight, RS422) EnDat2.1, EnDat2.2
Size / Weight	
HxWxD [mm]	199x80x130
Weight [kg]	2.0
Housing / protection class	Enclosed metal housing, IP20

Example: System Layout

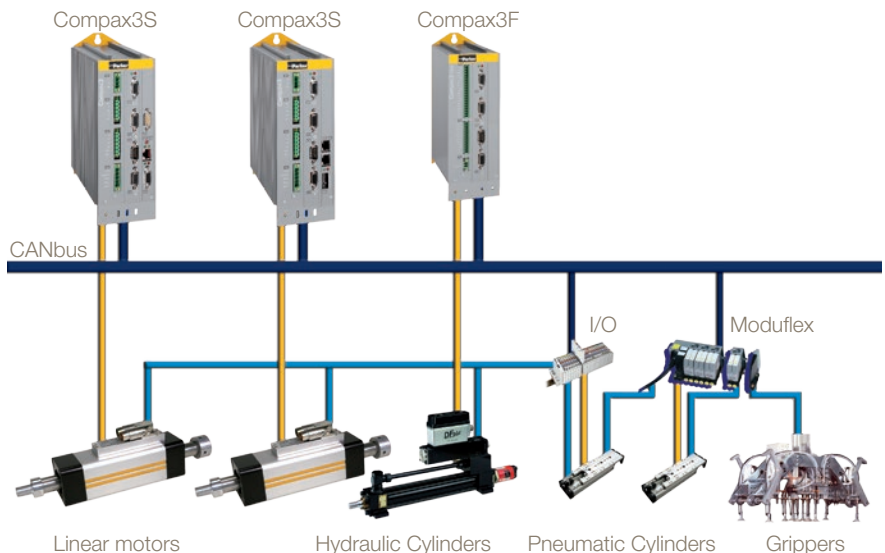

Technical Characteristics

Technical Data

Compax3S

Compax3		S025V2	S063V2	S100V2	S150V2	S015V4	S038V4	S075V4	S150V4	S300V4 ⁽¹⁾
	Unit									
Power supply and device currents										
Power supply	[V]	1*230/240 VAC (80...253 VAC) / 50...60 Hz		3*230/240 VAC (80...253 VAC) / 50...60 Hz		3*400/480 VAC (80...528 VAC) / 50...60 Hz				
Output nominal current (rms)	[A]	2.5	6.3	10	15	1.5	3.8	7.5	15	30
Peak current (<5 s)	[A]	5.5	12.6	20.0	30.0	4.5	9.0	15.0	30.0	60.0
Power	[kVA]	1.0	2.5	4.0	6.0	1.25	3.1	6.2	11.5	25.0
Control voltage	[V]	24 VDC ±10 %, ripple <1 Vpp								
Electric current drain	[A]	0.8 A (Compax3) (+ digital outputs 0.1 A each + motor brake up to 1.6 A)								
Dynamic Brake										
Capacitance	[µF]	560	1120	780	1170	235	235	470	690	1100
Storable energy	[Ws]	15 @230 V	30 @230 V	21 @230 V	31 @230 V	37@400 V 21@480 V	37@400 V 21@480 V	75@400 V 42@480 V	110@400 V 61@480 V	176@400 V 98@480 V

⁽¹⁾ Operation with capacitor module ModulC4.

Compax3H

Compax3		H050V4		H090V4		H125V4		H155V4	
	Unit								
Power supply and device currents									
Power supply	[V]	3*400/480 VAC (350...528 VAC) / 50...60 Hz							
Output nominal current (rms)	[A]	50.0		90.0		125.0		155.0	
Peak current (<5 s)	[A]	75.0		135.0		187.5		232.5	
Power	[kVA]	35.0		70.0		91.0		109.0	
Control voltage	[V]	24 VDC ±10 %, ripple <1 Vpp							
Electric current drain	[A]	0.8 A (Compax3) (+ digital outputs 0.1 A each + motor brake up to 1.6 A)							
Dynamic Brake									
Capacitance	[µF]	2600		3150		5000		5000	
Storable energy	[Ws]	602@400 V 419@480 V		729@400 V 507@480 V		1158@400 V 806@480 V		1158@400 V 806@480 V	

Compax3M

Compax3		M050D6		M100D6		M150D6		M300D6	
	Unit								
Power supply and device currents									
Power supply	[V]	325...679 VDC (Rated voltage 560 VDC)							
Output nominal current (rms)	[A]	5		10		15		30	
Peak current (<5 s)	[A]	10		20		30		60	
Power (@ 560 VDC)	[kVA]	3.33		6.66		10		20	
Dynamic Brake									
Capacitance	[µF]	110		220		220		440	
Storable energy	[Ws]	18@400 V 10@480 V		37@400 V 21@480 V		37@400 V 21@480 V		74@400 V 42@480 V	

PSUP Mains module

Mains Module	Unit	PSUP10			PSUP20			PSUP30 ⁽¹⁾		
Power supply		3*230...480 VAC ±10 % 50...60 Hz (Rated voltage 3*400 VAC)								
Output Voltage		325...680 VDC ±10 %								
Power supply	[VAC]	230	400	480	230	400	480	230	400	480
Output power	[kVA]	6	10	10	12	20	20	18	30	30
Pulse power (<5 s)	[kVA]	12	20	20	24	40	40	34	60	60
Control voltage		24 VDC ±10 %								
Maximum ripple		<1 Vpp								
Electric current drain	[A]	0.2 A			0.3 A			0.3 A		
	[A]	C3M050D6: 0.85 A		C3M100D6: 0.85 A		C3M150D6: 0.85 A		C3M300D6: 1.0 A		
		(+ total load of the digital outputs + current for motor holding brake up to 1.6 A)								

⁽¹⁾ Operation of the PSUP30 only with line choke"Required line choke for the PSUP30: 0.45 mH / 55 A" see page 27

Safety Technology

Compax3S	STO (Safe torque off) in accordance with EN ISO 13849:2008, category 3:PL=d/e. Certified: BG-PRÜFZERT
Compax3M	<ul style="list-style-type: none"> Standard S1 <ul style="list-style-type: none"> STO (Safe torque off) in accordance with EN ISO 13849:2008, category 3:PL=e. Certified: BG-PRÜFZERT Enhanced (S3 Option) <ul style="list-style-type: none"> The Compax3M device with option S3 complies with the requirements of the test principles (Kat. 4 / PL e PL=e to EN ISO 13849-1, SIL CL 3 in accordance with EN61800-5-1 / EN 62061 / EN 61508) and may be used in applications up to cat. 4 / PL e in accordance with EN ISO 13849-1 and SIL 3 in accordance with EN 62061 / EN 61508.

Positioning

Positioning on the motor shaft	<ul style="list-style-type: none"> Resolver (option F10) <ul style="list-style-type: none"> Resolution: 16 Bit (= 0.005°) Absolute accuracy: +/-0.167° SinCos® (Option F11) <ul style="list-style-type: none"> Position resolution: 13.5Bit/Encoder sine period => 0.03107°/encoder resolution Direct drives (F12) <ul style="list-style-type: none"> Maximum position resolution: Linear: 24 bits per motor magnet spacing Rotary: 24 bits per motor revolution For 1 Vpp sine-cosine encoders (e.g. EnDat): 13.5 bits / graduation of the encoder scale. For RS422 encoders: 4xEncoder resolution / Encoder Bypass possible. Accuracy of the feedback zero pulse acquisition = accuracy of the feedback resolution. For analog hall sensors with 1 Vpp signal: 13.5 bits / motor magnet spacing <p>The exactitude of the position signal is above all determined by the type and exactitude of the feedback system used.</p>
Setpoint generator	<ul style="list-style-type: none"> Jerk-limited ramps Travel data in increments, mm, inch or variable by scale factor Specification of speed, acceleration, deceleration and jerk
Monitoring functions	<ul style="list-style-type: none"> Power/auxiliary supply range Motor power stage temperature/stall protection Following error monitoring

Supported Motor and Feedback Systems

Motors

- Sinusoidally commutated synchronous motors
 - Maximum electrical turning frequency: 1000 Hz
 - Maximum velocity at 8 pole motors: 15 000 min⁻¹
 - Maximum speed: 60*1000/number of pole pairs in min⁻¹
- Sinusoidal commutated asynchronous motors
 - Maximum electrical turning frequency: 1000 Hz
 - Maximum speed: 60*1000/number of pole pairs - slip in min⁻¹
- 3 phase synchronous direct drives

Feedback systems

Option F10 for

- Resolver
 - Litton: JSSBH-15-E-5, JSSBH-21-P4, RE-21-1-A05, RE-15-1-B04
 - Tamagawa: 2018N321 E64
 - Siemens: 23401-T2509-C202

Option F11 for

- Sine Cosine - Encoder with Hiperface® -
 - Rotary feedback with HIPERFACE® interface in Single or Multiturn version (absolute position up to 4096 motor revolutions):
 - For example: SRS/M50, SRS/M50S, SKS/M36, SEK52, SEL57, SEK37, SEL37, SEK 90/180/260

Option F12 for

- EnDat 2.1 or EnDat 2.2 feedback systems with/without incremental track (sine-cosine track)
 - Rotary feedback in Single or Multiturn version (absolute position up to 4096 motor revolutions):
 - Linear feedbacks
- Analog hall sensors
 - Sine - cosine signal (max. 5 VSS; typical 1 VSS) 90° offset
 - U-V Signal (max. 5 VSS; typical 1 VSS) 120° offset
- Linear or rotary encoders
 - U-V Signal (max. 5 VSS; typical 1 VSS) (max. 400 kHz) or
 - TTL (RS422) (max. 5 MHz) with the following modes of commutation: Automatic commutation or digital hall sensors
- Distance coded feedback systems
 - Distance coding with 1VSS interface
 - Distance coding with RS422 - Interface
 - Feedback error compensation: Automatic feedback error compensation

Ambient Conditions

Temperature range

	Compax3S & Compax3H	PSUP / Compax3M
	0...45 °C	0...40 °C

Tolerated humidity

max. relative air humidity <=85% class 3K3; non-condensing

Elevation of operating site

- ≤1000 m asl for 100 % load ratings
- ≤2000 m above sea level for 1 % / 100 m power reduction
- please inquire for greater elevations

Degree of protection

IP20 protection level in accordance with EN 60529

Ports

COM ports	<ul style="list-style-type: none"> • RS232, 115200 Baud • RS485, (2- or 4-wire) 9600, 19200, 38400, 57600 or 115200 Bauds • USB (Compax3M), USB 2.0 Full Speed compatible
Bus systems	<ul style="list-style-type: none"> • PROFIBUS DP V0-V2 (I20), 12 Mbit/s, PROFIdrive profile drive technology • CANopen (CiADS402) (I21), 20...1000 Kbit/s, SDO1, PDO1, ... PDO4 • DeviceNet (I22), up to 32 bytes I/O, 125...500 Kbit/s, up to 63 slaves • Ethernet Powerlink (I30), 100 Mbit/s (FastEthernet), from 500 µs (typ. 1 ms) cycle time • EtherCAT (I31), 100 Mbit/s (FastEthernet), from 125 µs (typ. 1 ms) cycle time • PROFINET (I32) certified, PROFINET IO (RT), 100BASE-TX (Full Duplex)
 Inputs and outputs	<ul style="list-style-type: none"> • 8 control inputs: 24 VDC / 10 kOhm • 4 control outputs: Active HIGH / short-circuit proof/ 24 V / 100 mA • 2 analog inputs (14 Bit) • 2 analog outputs (8 Bit)
Encoder simulation	<ul style="list-style-type: none"> • 4-16384 increments per revolution (zero pulse can be feely selected within one motor revolution) • Limit frequency: 620 kHz

Standards and Conformance

Insulation requirements	<ul style="list-style-type: none"> • Protection class in accordance with EN 60664-1 • Protection against human contact with dangerous voltages: in accordance with EN 61800-5-1 • Overvoltage: Voltage category III in accordance with EN 60664-1 • Level of contamination 2 in accordance with EN 60664-1 and EN 61800-5-1
CE compliance	<ul style="list-style-type: none"> • EG low voltage directive 2006/95/ECEN 61800-5-1, Standard for electric power drives with settable speed; requirements to electric safety EN 60664-1, isolation coordinates for electrical equipment in low-voltage systems EN 60204-1, Machinery norm, partly applied • EC-EMC-directive 2004/108/EC EN 61800-3, product standard for speed adjustable drives
UL certification	<ul style="list-style-type: none"> • UL conform according to UL508C <ul style="list-style-type: none"> • Compax3S: Recognized Component Mark for Canada and the US • PSUP / Compax3M & Compax3H: UL Listing
RoHS Compliance	<p>Available for Compax3S, Compax3M, Compax3F Complies with European Union Directive 2002/95/EC - Restriction of Hazardous Substances (RoHS)</p>

Dimensions

Compax3S

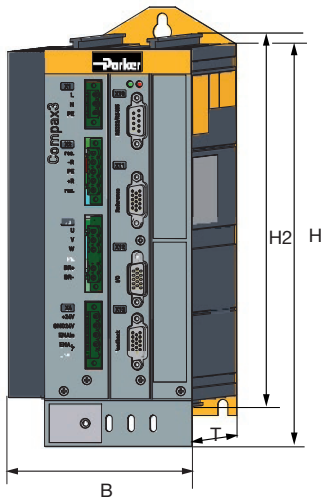

Device:	Dimensions [mm]				Weight [kg]
	H	B	T	H2	
Compax3					
S025V2	216	84	172	203	2.0
S063V2		100			2.5
S100V2		115			4.3
S150V2 / S150V4		158			6.8
S015V4	273	84		259	3.1
S038V4		100			3.5
S075V4		115			4.3
S300V4	380	175		391	10.9

Compax3H

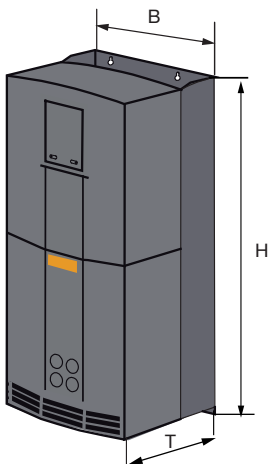

Device:	Dimensions [mm]			Weight [kg]
	H	B	T	
Compax3				
H050V4	453	252	245	17.4
H090V4	669	257	312	32.5
H125V4	720	257	355	41.0
H155V4	720	257	355	41.0

PSUP & Compax3M

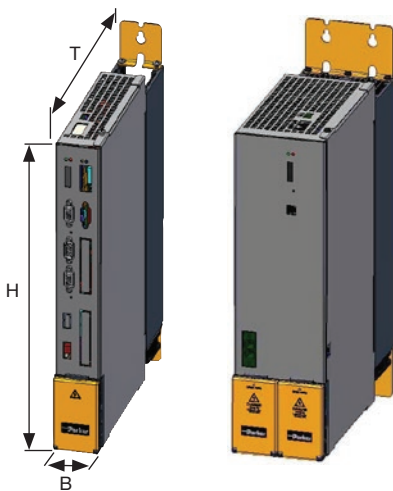

Device:	Dimensions [mm]			Weight [kg]
	H	B	T	
Compax3				
M050D6	360	50	263	3.5
M100D6	360	50	263	3.6
M150D6	360	50	263	3.6
M300D6	360	100	263	5.25
Mains Module				
PSUP10D6	360	50	263	3.95
PSUP20D6	360	100	263	6.3
PSUP30D6	360	100	263	6.3

Enclosure

Insulation:
VDE 0160 / Protection class IP20 in accordance with EN 60 529 (not for C3H1xxV4)

Accessories and Options

Software and Tools

C3 ServoManager

- Guided configuration
 - Automatic querying of all necessary entries
 - Graphical support
- Setup mode
 - Manual motion of individual axes
 - Predefined profiles
 - Convenient operation
 - Storage of defined profiles
 - Automatic determination of the moment of inertia
- integrated 4-channel oscilloscope
 - Signal tracking directly on the PC
 - Various modes (single/normal/auto/roll)
 - Zoom function
 - Export as image or table (for example to Excel)

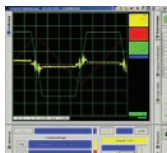

MotorManager

- Complete library for Parker motors
 - Integration of customer motors
 - Determination of motor characteristics and of the motor position feedback



HydraulicsManager

- Valve library for Parker valves
 - Integration of customer valves

CamDesigner

Cam creation tool

- Standard and expert mode
- Evaluation of the motion profiles
- Verification of the drive selection
- Transition laws from the VDI directive 2143

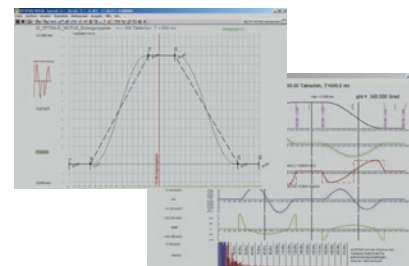

Programming

CoDeSys

CoDeSys is a development environment for programming that saves a significant amount of time as applications are created.

- Powerful developing environment, worldwide established
- Universal programming platform for various devices
- Complete offline simulation
- Visual elements
- Library management for user-defined applications
- Context-sensitive help wizard
- Data exchange between devices from different manufacturers
- Complete online functionality
- Sophisticated technological features
- Free of charge

IEC61131-3

IEC 61131-3 is the only company- and product independent programming language with worldwide support for industrial automation devices.

IEC 61131-3 includes graphical and textual programming languages:

- Instruction list
- Structured text
- Ladder diagram
- Sequential function chart
- Function block diagram
- Integrated standards offer:
 - a trusted programming environment
 - standardized programming
- Integrated standards reduce:
 - the overhead of development
 - maintenance costs
 - software upkeep
 - training overhead
- Integrated standards increase:
 - productivity
 - software quality
 - concentration on core competence

PLCopen

PLCopen is an organization that plays a significant role in supporting the IEC 61131-3 programming language. It is independent of individual companies or products. Its specific tasks also include defining basic processes relevant to motion. The PLCopen organization consists of both users and manufacturers of automation components. Parker Hannifin is an active member of the "Motion Control" task force. This represents a great advantage to users of Parker drive technology, since they are constantly able to profit directly from the latest developments in PLCopen.

Parker is a member of the "CoDeSys Automation Alliance"



Signal Analysis for the System Identification

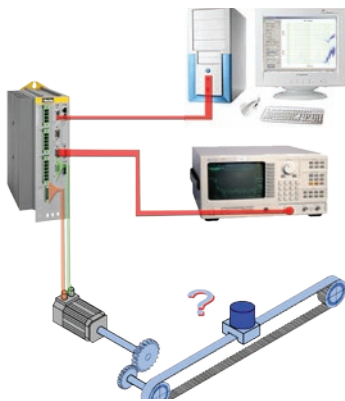

formerly

Implementation prerequisites:

- Expensive and complex measurement technology required
- Special knowledge required
- Implementation only possible in an open control loop (=dangerous)

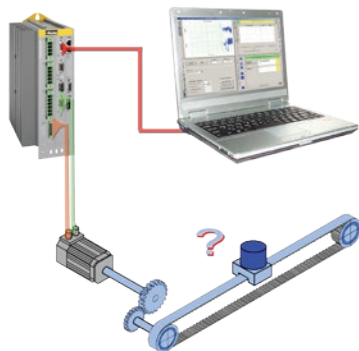

today

Implementation prerequisites:

- Implementation with a common PC
- Simple and safe operation with the Compax3 ServoManager Software
- No special knowledge required
- The safety functions implemented in the servo drive ensure safe measurement in a closed position control loop

What do these functions provide?

Analysis and optimization of the mechanic system

Transmission behavior of the mechanic system

- Simple measurement of the mechanic dynamic behavior, therefore:
 - Possibilities to improve the mechanic construction can be spotted.
 - Increased stiffness and precision of the entire system. (improved mechanic system = improved controller performance)

Modal analysis

- Vibration analysis of the mechanic construction by specification of a sinusoidal motor force with a defined frequency.
- It is often possible to work without additional excitation by electrodynamic shakers or pulse hammers.

Analysis and optimization of the control

Transmission behavior of the mechanic system

- Better and faster controller optimization due to the knowledge of the transmission behavior of the control path.
- Specific suppression of disturbances at the mechanic resonance points with the aid of notch or low-pass filters.

Transmission behavior of the control

- Quality assessment of the control with respect to the response behavior:
 - In the time range by step response
 - In the frequency range by frequency response
 - Optimization of the control by application of stability criteria from the control theory (e.g. Nyquist criterion or Hurwitz criterion)
- Quality assessment of the control with respect to the disturbance behavior:
 - In the time range by the disturbance current - step response¹
 - In the frequency range by measurement and analysis of the resilience - frequency response²

¹ Emulation of an external volatile change in the disturbance force.

² The compliance frequency response states the size of the control deviation caused by a disturbance force in dependence of its frequency.

Order Code

Devices: Compax3

	1	2	3	4	5	6	7	8
Example:	C3	S	025 V2	F10	I10	T10	M00	

1 Device family

C3 Compax3

2 Device type

S Single-axis
H High power
M Multi-axis device
F Hydraulics controller (C3F001D2F12)

3 Device currents static/dynamic; supply voltage

Compax3S

025 V2 2.5 A / 5 A; 230 VAC (single phase)
063 V2 6.3 A / 12.6 A; 230 VAC (single phase)
100 V2 10 A / 20A; 230 VAC (3 phase)
150 V2 15 A / 30 A; 230 VAC (3 phase)
015 V4 1.5 A / 4.5 A; 400 VAC (3 phase)
038 V4 3.8 A / 9 A; 400 VAC (3 phase)
075 V4 7.5 A / 15.0 A; 400 VAC (3 phase)
150 V4 15.0 A / 30.0 A; 400 VAC (3 phase)
300 V4 30.0 A / 60.0 A; 400 VAC (3 phase) ⁽¹⁾

Compax3H

050 V4 50 A / 75 A; 400 VAC (3 phase)
090 V4 90 A / 135 A; 400 VAC (3 phase)
125 V4 125 A / 187.5 A; 400 VAC (3 phase) ⁽²⁾
155 V4 155 A / 232.5 A; 400 VAC (3 phase) ⁽²⁾

Compax3M

050 D6 5.0 A / 10.0 A; 400 VAC (3 phase)
100 D6 10 A / 20 A; 400 VAC (3 phase)
150 D6 15 A / 30 A; 400 VAC (3 phase)
300 D6 30 A / 60 A; 400 VAC (3 phase)

Compax3F

001 D2 24 VDC

4 Feedback

F10 Resolver (not for C3F)
F11 SinCos© (Hiperface) (not for C3F)
F12 Encoder, Sine/cosine with/without hall, EnDat

5 Interface

I10 Step/direction / analog input (only I10T10)
I11 Positioning via inputs/outputs (only I11T11)
I12 Positioning via I/Os or RS232 / RS485 / USB
I20 PROFIBUS DP V0/V1/V2 (12 Mbaud)
I21 CANopen
I22 DeviceNet
I30 Ethernet Powerlink
I31 EtherCAT
I32 PROFINET

6 Technology function

T10 Servo controller (only I10)
T11 Positioning
T30 Motion control programmable in accordance with IEC 61131-3
T40 Motion control programmable in accordance with IEC 61131-3 & electronic cam

7 Options

M00 No additional supplement
M10 Extension by 12 digital I/Os & HEDA Motionbus (not for T10, T11)
M11 HEDA Motionbus (not for T10, T11)
M12 Extension by 12 digital I/Os (not for T10, T11)
M21 Analog current / voltage inputs (0...20 mA) and (-10...+10 V) (3 each)

8 Optional safety technology for C3M

S1 Safe torque off (furnished with the device)
S3 Extended safety technology

⁽¹⁾ Operation of the C3S300V4 with capacitor module ModulC4.
⁽²⁾ external voltage supply for ventilator fan required. Available in two versions for single phase feed. Standard: 220/240 VAC: 140 W, on request: 110/120 VAC: 130 W

Software dongle for SafePLC

	1
Example:	SafePLC

1 Accessories

SafePLC Dongle for programming the safety technology for the C3M option S3

PROFIBUS and PROFINET are registered trademarks of PROFIBUS & PROFINET International (PI). EtherCAT® is a registered trademark and patented technology, licensed by Beckhoff Automation GmbH, Germany.

Accessories

Power module: PSUP

	1	2	3	4	5
Example:	PSU	P	10	D6	USB M00

1 Device family	PSU	Mains Module
2 Device type	P	Mains Module
3 Nominal power; supply voltage	10 D6	10 kW; 400 VAC (3 phase)
	20 D6	20 kW; 400 VAC (3 phase)
	30 D6	30 kW; 400 VAC (3 phase) ⁽¹⁾
4 Interface	USB	USB connection
5 Options	M00	no additional supplement

⁽¹⁾ Operation of the PSUP30 only with line choke.
Required line choke for the PSUP30: 0.45 mH / 55 A

We offer the following line chokes:

LCG-0055-0.45 mH

(WxDxH: 180x140x157 mm; 10 kg)

LCG-0055-0.45 mH-UL

(with UL certification, WxDxH: 180x170x157 mm; 15 kg)

Connection set for Compax3 and PSUP

Mating plug connector (furnished with the device)

	1
Example:	ZBH02/02

1 Accessories	ZBH02/01	for C3S0xxV2
	ZBH02/02	for C3S0xxV4 / S150V4 / S1xxV2
	ZBH02/03	for C3S300V4
	ZBH02/04	for C3F00xD2
	ZBH04/01	for C3M050D6, C3M100D6, C3M150D6
	ZBH04/02	for C3M300D6
	ZBH04/03	for PSUP10
	ZBH04/04	for PSUP20/PSUP30

Motor Cable

	1	2
Example:	MOK	55/02

1 Accessories	MOK	Motor cable ⁽²⁾
2 Type		for SMH / MH56 / MH70 / MH105 ⁽³⁾
	55/.... ⁽¹⁾	1.5 mm ² ; to 13.8 A
	54/.... ⁽¹⁾	1.5 mm ² ; up to 13.8 A cable chain compatible
	56/.... ⁽¹⁾	2.5 mm ² ; to 18.9 A
	57/.... ⁽¹⁾	2.5 mm ² ; up to 18.9 A cable chain compatible
		for MH145 / MH205 ⁽⁴⁾
	60/.... ⁽¹⁾	1.5 mm ² ; to 13.8 A
	63/.... ⁽¹⁾	1.5 mm ² ; up to 13.8 A cable chain compatible
	59/.... ⁽¹⁾	2.5 mm ² ; to 18.9 A
	64/.... ⁽¹⁾	2.5 mm ² ; up to 18.9 A cable chain compatible
	61/.... ⁽¹⁾	6 mm ² ; up to 32.3 A cable chain compatible
	62/.... ⁽¹⁾	10 mm ² ; up to 47.3 A cable chain compatible

MOK55 and MOK54 are also possible for linear motors LXR406, LXR412.

Feedback cable

	1
Example:	REK42/02

1 Accessories		for MH/SMH motors
	REK42/.... ⁽¹⁾	Resolver cable ⁽²⁾
	REK41/.... ⁽¹⁾	Resolver cable ⁽²⁾ cable chain compatible
	GBK24/.... ⁽¹⁾	SinCos© feedback cable ⁽²⁾ cable chain compatible
	GBK38/.... ⁽¹⁾	EnDat 2.1 feedback cable ⁽²⁾ cable chain compatible (C3S, H, M)
	GBK23/.... ⁽¹⁾	Encoder cable ⁽²⁾ cable chain compatible
		for linear motors
	GBK33/.... ⁽¹⁾	Feedback cable to LXR cable chain compatible
	GBK40/.... ⁽¹⁾	SSI, Start Stop (C3F)
	GBK41/.... ⁽¹⁾	EnDat 2.1 Feedback cable (C3F) cable chain compatible
	GBK56/.... ⁽¹⁾	EnDat 2.2 feedback cable (C3S, H, M) cable chain compatible
	GBK57/.... ⁽¹⁾	EnDat 2.2 Feedback cable (C3F) cable chain compatible

⁽¹⁾ - ⁽⁴⁾ see "Length code for cables" (page 28)



Order code for interface cables and connectors

	1
Example:	SSK01/01

1 Accessories	
SSK01/.... ⁽¹⁾	RS232 (PC-Compax3)
SSK33/.... ⁽¹⁾	USB (PC-PSUP)
SSK21/.... ⁽¹⁾	Ref / analog - with flying leads (X11, X13 @C3F001D2)
SSK22/.... ⁽¹⁾	Digital I/Os with flying leads (X12 / X22)
SSK23/.... ⁽¹⁾	Ref /analog for I/O terminal block (X11)
SSK24/.... ⁽¹⁾	Digital I/Os for I/O terminal block (X12, X22)
SSK25/.... ⁽¹⁾	RS232 (PC-Pop)
SSK27/./.. ⁽⁶⁾	RS485 (C3-Pop for more than one C3H on request)
SSK28/.... ⁽⁵⁾	RJ45 Crossover cable (C3 HEDA-HEDA, PC-C3 powerPLmC, C3M-C3M communication, PROFINET, EtherCAT, Ethernet Powerlink)
SSK29/.... ⁽¹⁾	Encoder coupling of 2 axes (X11-X11)
SSK31/.... ^{(1),(7)}	Cable Modem-Compax3 X10
SSK32/20	Adapter cable for C3H to SSK01 (15 cm furnished with the device)
VBK17/01	RS232 connection controller-programming interface (furnished with the device for C3H X10)
BUS07/01	Bus terminal connector (1st. and last C3 in the HEDA bus/or multi-axis system)
SSL01 ⁽⁷⁾	PROFIBUS cable ⁽²⁾ not prefabricated
BUS08/01	Profibus connector Plug with 2 cable inputs (1 arriving, 1 continuing PROFIBUS cable), as well as a switch for activating the terminal resistor
SSL02 ⁽⁷⁾	CAN Bus cable ⁽²⁾ not prefabricated
BUS10/01	CAN bus connector Plug with 2 cable inputs (1x arriving, 1x continuing CANbus cable), as well as a switch for activating the terminal resistor

^{(1) - (6)} see "Length code for cables" (page 28)
DeviceNet -A mating plug is included in the delivery. Additional information on DeviceNet wiring can be found under:
www.odva.org

Length code for cables

⁽¹⁾ **Length code 1 (Example: SSK01/09 = length 25 m)**

Length [m]	1.0	2.5	5.0	7.5	10.0	12.5	15.0	20.0	25.0	30.0	35.0	40.0	45.0	50.0
Order code	01	02	03	04	05	06	07	08	09	10	11	12	13	14

⁽²⁾ Color according to DESINA

⁽³⁾ with motor connector

⁽⁴⁾ with cable eye for motor terminal box

⁽⁵⁾ **length code 2 for SSK28**

Length [m]	0.17	0.25	0.5	1.0	3.0	5.0	10.0
Order code	23	20	21	01	22	03	05

⁽⁶⁾ **Order code: SSK27/nn/..**

Length A (Pop - 1st. Compax3) variable (the last two numbers corresponding to the cable length code for example SSK27/nn/01)

Length B (1st. Compax3 - 2nd. Compax3 - ... nth. Compax3) fixed 50 cm (only if there is more than 1 Compax3, i.e. nn greater than 01)

Number n (the last two digits)

⁽⁷⁾ Number ordered corresponds to the cable length in m



Braking resistors

	1	2
Example:	BRM	05/01

1 Accessories	
BRM	Braking resistor
2 Type	
05/01	56 Ω / 0.18 kW _{cont.} (for C3S063V2, C3S075V4)
05/02	56 Ω / 0.57 kW _{cont.} (for C3S075V4)
08/01	100 Ω / 60 W _{cont.} (for C3S025V2, C3S038V4)
10/01	47 Ω / 0.57 kW _{cont.} (for C3S150V4)
04/01	15 Ω / 0.57 kW _{cont.} (for C3S150V2, C3S300V4)
04/02	15 Ω / 0.74 kW _{cont.} (for C3S150V2, C3S300V4)
04/03	15 Ω / 1.5 kW _{cont.} (for C3S300V4)
09/01	22 Ω / 0.45 kW _{cont.} (for C3S100V2)
11/01	27 Ω / 3.5 kW _{cont.} (for C3H0xxV4)
13/01	30 Ω / 0.5 kW _{cont.} for PSUP10D6, for PSUP20D6 (2x30Ω parallel)
14/01	15 Ω / 0.5 kW _{cont.} (for PSUP10D6 2 x 15 Ω in series for PSUP20, PSUP30)
12/01	18 Ω / 4.5 kW _{cont.} (for C3H1xxV4, PSUP30)

Mains filter

For radio interference suppression and compliance with the emission limit values for CE conform operation.

	1	2
Example:	NFI	01/01

1 Accessories	
NFI	Mains filter
2 Type	
01/01	for C3S025V2 or S063V2
01/02	for C3S0xxV4, S150V4 or S1xxV2
01/03	for C3S300V4
02/01	for C3H050V4
02/02	for C3H090V4
02/03	for C3H1xxV4
03/01	for PSUP10 Reference axis combination 3x480 V 25 A 6x10 m motor cable length
03/02	for PSUP10 Reference axis combination 3x480 V 25 A 6x50 m motor cable length
03/03	for PSUP20, PSUP30 Reference axis combination 3x480 V 50 A 6x50 m motor cable length

Motor output choke

For disturbance suppression when the motor connecting cables are long

	1	2
Example:	MDR	01/04

1 Accessories	
MDR	Motor output choke (for Compax3S, Compax3M >20 m motor cable)
2 Type	
01/01	up to 16 A rated motor current
01/02	up to 30 A rated motor current
01/04	up to 6.3 A rated motor current

Capacitor module

	1
Example:	ModulC4

1 Accessories	
ModulC4	1100 µF for C3S300V4 optional for C3H

Inputs/Outputs:

Terminal block: EAM06/..

For additional wiring of the inputs/outputs:

- Can be mounted in the control cabinet via top hat rail
- Connection EAM06/.. via SSK23/.. to X11, SSK24/.. to X12



Terminal block

	1	2
Example:	EAM	06/01

1 Accessories	
EAM	Terminal block
2 Type	
06/01	I/Os without luminous indicator (for X11, X12, X22)
06/02	I/Os with luminous indicator (for X12, X22)





Parker's Motion & Control Technologies

At Parker, we're guided by a relentless drive to help our customers become more productive and achieve higher levels of profitability by engineering the best systems for their requirements. It means looking at customer applications from many angles to find new ways to create value. Whatever the motion and control technology need, Parker has the experience, breadth of product and global reach to consistently deliver. No company knows more about motion and control technology than Parker. For further info call 00800 27 27 5374



Aerospace Key Markets

Aftermarket services
Commercial transports
Engines
General & business aviation
Helicopters
Launch vehicles
Military aircraft
Missiles
Power generation
Regional transports
Unmanned aerial vehicles

Key Products

Control systems & actuation products
Engine systems & components
Fluid conveyance systems & components
Fluid metering, delivery & atomization devices
Fuel systems & components
Fuel tank inerting systems
Hydraulic systems & components
Thermal management
Wheels & brakes



Climate Control Key Markets

Agriculture
Air conditioning
Construction Machinery
Food & beverage
Industrial machinery
Life sciences
Oil & gas
Precision cooling
Process
Refrigeration
Transportation

Key Products

Accumulators
Advanced actuators
CO₂ controls
Electronic controllers
Filter driers
Hand shut-off valves
Heat exchangers
Hose & fittings
Pressure regulating valves
Refrigerant distributors
Safety relief valves
Smart pumps
Solenoid valves
Thermostatic expansion valves



Electromechanical Key Markets

Aerospace
Factory automation
Life science & medical
Machine tools
Packaging machinery
Paper machinery
Plastics machinery & converting
Primary metals
Semiconductor & electronics
Textile
Wire & cable

Key Products

AC/DC drives & systems
Electric actuators, gantry robots & slides
Electrohydraulic actuation systems
Electromechanical actuation systems
Human machine interface
Linear motors
Stepper motors, servo motors, drives & controls
Structural extrusions



Filtration Key Markets

Aerospace
Food & beverage
Industrial plant & equipment
Life sciences
Marine
Mobile equipment
Oil & gas
Power generation & renewable energy
Process
Transportation
Water Purification

Key Products

Analytical gas generators
Compressed air filters & dryers
Engine air, coolant, fuel & oil filtration systems
Fluid condition monitoring systems
Hydraulic & lubrication filters
Hydrogen, nitrogen & zero air generators
Instrumentation filters
Membrane & fiber filters
Microfiltration
Sterile air filtration
Water desalination & purification filters & systems



Fluid & Gas Handling

Key Markets

Aerial lift
Agriculture
Bulk chemical handling
Construction machinery
Food & beverage
Fuel & gas delivery
Industrial machinery
Life sciences
Marine
Mining
Mobile
Oil & gas
Renewable energy
Transportation

Key Products

Check valves
Connectors for low pressure fluid conveyance
Deep sea umbilicals
Diagnostic equipment
Hose couplings
Industrial hose
Mooring systems & power cables
PTFE hose & tubing
Quick couplings
Rubber & thermoplastic hose
Tube fittings & adapters
Tubing & plastic fittings



Hydraulics

Key Markets

Aerial lift
Agriculture
Alternative energy
Construction machinery
Forestry
Industrial machinery
Machine tools
Marine
Material handling
Mining
Oil & gas
Power generation
Refuse vehicles
Renewable energy
Truck hydraulics
Turf equipment

Key Products

Accumulators
Cartridge valves
Electrohydraulic actuators
Human machine interfaces
Hybrid drives
Hydraulic cylinders
Hydraulic motors & pumps
Hydraulic systems
Hydraulic valves & controls
Hydrostatic steering
Integrated hydraulic circuits
Power take-offs
Power units
Rotary actuators
Sensors



Pneumatics

Key Markets

Aerospace
Conveyor & material handling
Factory automation
Life science & medical
Machine tools
Packaging machinery
Transportation & automotive

Key Products

Air preparation
Brass fittings & valves
Manifolds
Pneumatic accessories
Pneumatic actuators & grippers
Pneumatic valves & controls
Quick disconnects
Rotary actuators
Rubber & thermoplastic hose & couplings
Structural extrusions
Thermoplastic tubing & fittings
Vacuum generators, cups & sensors



Process Control

Key Markets

Alternative fuels
Biopharmaceuticals
Chemical & refining
Food & beverage
Marine & shipbuilding
Medical & dental
Microelectronics
Nuclear Power
Offshore oil exploration
Oil & gas
Pharmaceuticals
Power generation
Pulp & paper
Steel
Water/wastewater

Key Products

Analytical Instruments
Analytical sample conditioning products & systems
Chemical injection fittings & valves
Fluoropolymer chemical delivery fittings, valves & pumps
High purity gas delivery fittings, valves, regulators & digital flow controllers
Industrial mass flow meters/ controllers
Permanent no-weld tube fittings
Precision industrial regulators & flow controllers
Process control double block & bleeds
Process control fittings, valves, regulators & manifold valves



Sealing & Shielding

Key Markets

Aerospace
Chemical processing
Consumer
Fluid power
General Industrial
Information technology
Life sciences
Microelectronics
Military
Oil & gas
Power generation
Renewable energy
Telecommunications
Transportation

Key Products

Dynamic seals
Elastomeric o-rings
Electro-medical instrument design & assembly
EMI shielding
Extruded & precision-cut, fabricated elastomeric seals
High temperature metal seals
Homogeneous & inserted elastomeric shapes
Medical device fabrication & assembly
Metal & plastic retained composite seals
Shielded optical windows
Silicone tubing & extrusions
Thermal management
Vibration dampening

Parker Worldwide

Europe, Middle East, Africa

AE – United Arab Emirates, Dubai
Tel: +971 4 8127100
parker.me@parker.com

AT – Austria, Wiener Neustadt
Tel: +43 (0)2622 23501-0
parker.austria@parker.com

AT – Eastern Europe, Wiener Neustadt
Tel: +43 (0)2622 23501 900
parker.easteurope@parker.com

AZ – Azerbaijan, Baku
Tel: +994 50 2233 458
parker.azerbaijan@parker.com

BE/LU – Belgium, Nivelles
Tel: +32 (0)67 280 900
parker.belgium@parker.com

BG – Bulgaria, Sofia
Tel: +359 2 980 1344
parker.bulgaria@parker.com

BY – Belarus, Minsk
Tel: +48 (0)22 573 24 00
parker.poland@parker.com

CH – Switzerland, Etoy
Tel: +41 (0)21 821 87 00
parker.switzerland@parker.com

CZ – Czech Republic, Klecany
Tel: +420 284 083 111
parker.czechrepublic@parker.com

DE – Germany, Kaarst
Tel: +49 (0)2131 4016 0
parker.germany@parker.com

DK – Denmark, Ballerup
Tel: +45 43 56 04 00
parker.denmark@parker.com

ES – Spain, Madrid
Tel: +34 902 330 001
parker.spain@parker.com

FI – Finland, Vantaa
Tel: +358 (0)20 753 2500
parker.finland@parker.com

FR – France, Contamine s/Arve
Tel: +33 (0)4 50 25 80 25
parker.france@parker.com

GR – Greece, Athens
Tel: +30 210 933 6450
parker.greece@parker.com

HU – Hungary, Budaörs
Tel: +36 23 885 470
parker.hungary@parker.com

IE – Ireland, Dublin
Tel: +353 (0)1 466 6370
parker.ireland@parker.com

IL – Israel
Tel: +39 02 45 19 21
parker.israel@parker.com

IT – Italy, Corsico (MI)
Tel: +39 02 45 19 21
parker.italy@parker.com

KZ – Kazakhstan, Almaty
Tel: +7 7273 561 000
parker.easteurope@parker.com

NL – The Netherlands, Oldenzaal
Tel: +31 (0)541 585 000
parker.nl@parker.com

NO – Norway, Asker
Tel: +47 66 75 34 00
parker.norway@parker.com

PL – Poland, Warsaw
Tel: +48 (0)22 573 24 00
parker.poland@parker.com

PT – Portugal
Tel: +351 22 999 7360
parker.portugal@parker.com

RO – Romania, Bucharest
Tel: +40 21 252 1382
parker.romania@parker.com

RU – Russia, Moscow
Tel: +7 495 645-2156
parker.russia@parker.com

SE – Sweden, Spånga
Tel: +46 (0)8 59 79 50 00
parker.sweden@parker.com

SK – Slovakia, Banská Bystrica
Tel: +421 484 162 252
parker.slovakia@parker.com

SL – Slovenia, Novo Mesto
Tel: +386 7 337 6650
parker.slovenia@parker.com

TR – Turkey, Istanbul
Tel: +90 216 4997081
parker.turkey@parker.com

UA – Ukraine, Kiev
Tel: +48 (0)22 573 24 00
parker.poland@parker.com

UK – United Kingdom, Warwick
Tel: +44 (0)1926 317 878
parker.uk@parker.com

ZA – South Africa, Kempton Park
Tel: +27 (0)11 961 0700
parker.southafrica@parker.com

North America

CA – Canada, Milton, Ontario
Tel: +1 905 693 3000

US – USA, Cleveland
Tel: +1 216 896 3000

Asia Pacific

AU – Australia, Castle Hill
Tel: +61 (0)2-9634 7777

CN – China, Shanghai
Tel: +86 21 2899 5000

HK – Hong Kong
Tel: +852 2428 8008

IN – India, Mumbai
Tel: +91 22 6513 7081-85

JP – Japan, Tokyo
Tel: +81 (0)3 6408 3901

KR – South Korea, Seoul
Tel: +82 2 559 0400

MY – Malaysia, Shah Alam
Tel: +60 3 7849 0800

NZ – New Zealand, Mt Wellington
Tel: +64 9 574 1744

SG – Singapore
Tel: +65 6887 6300

TH – Thailand, Bangkok
Tel: +662 186 7000

TW – Taiwan, Taipei
Tel: +886 2 2298 8987

South America

AR – Argentina, Buenos Aires
Tel: +54 3327 44 4129

BR – Brazil, Sao Jose dos Campos
Tel: +55 800 727 5374

CL – Chile, Santiago
Tel: +56 2 623 1216

MX – Mexico, Toluca
Tel: +52 72 2275 4200



EMEA Product Information Centre

Free phone: 00 800 27 27 5374

(from AT, BE, CH, CZ, DE, DK, EE, ES, FI, FR, IE, IL, IS, IT, LU, MT, NL, NO, PL, PT, RU, SE, SK, UK, ZA)

US Product Information Centre

Toll-free number: 1-800-27 27 537

www.parker.com