



aerospace
climate control
electromechanical
filtration
fluid & gas handling
hydraulics
pneumatics
process control
sealing & shielding



P3TJ Dry Air System

Totally clean and dry compressed air

Catalogue PDE2602TCUK August 2015



ENGINEERING YOUR SUCCESS.

P3TJ Dry Air System

The Problem

Compressed air is an essential power source that is widely used throughout industry. This safe, powerful and reliable utility can be the most important part of your production process.

However, your compressed air will contain water, dirt, wear particles and even degraded lubricating oil which all mix together to form an unwanted condensate. This condensate often acidic, rapidly wears tools and pneumatic machinery, blocks valves and orifices causing high maintenance and costly air leaks. It also corrodes piping systems and can bring your production process to an extremely expensive standstill!

The use of high efficiency compressed air filters fitted with condensate drains will remove the oil, water and dirt particles to eliminate the abrasive sludge in the compressed air system.

In many cases this action alone is not enough, as modern production systems and processes demand an even higher level of air quality. Where required, "point of use" desiccant air dryers can provide the correct air quality, without the need for drying the complete compressed air installation, which can be both costly and totally unnecessary.



The Efficient Solution

The Parker P3TJ Dry Air System range of desiccant air dryers, offers the user uncompromised performance from a dedicated "point of use" Clean Dry Air system. It is easy to install and will transform an ordinary process into a highly reliable and efficient production operation.

The P3TJ Dry Air System has been designed with "quick change" filter, dryer combi-cartridges and in-line air connections to facilitate easy maintenance.

The P3TJ Dry Air System totally cleans and dries compressed air down to -40°C (-40°F) pressure dewpoint.

For critical applications, a pressure dewpoint of -70°C (-100°F) is achievable.

The principles of the P3TJ Dry Air System are based upon well proven concepts which embody true innovation and excellent value for money with technically superior yet simple design, while leading the way in compressed air drying.



WARNING

FAILURE OR IMPROPER SELECTION OR IMPROPER USE OF THE PRODUCTS AND/OR SYSTEMS DESCRIBED HEREIN OR RELATED ITEMS CAN CAUSE DEATH, PERSONAL INJURY AND PROPERTY DAMAGE.

This document and other information from Parker Hannifin Corporation, its subsidiaries and authorized distributors provide product and/or system options for further investigation by users having technical expertise. It is important that you analyze all aspects of your application and review the information concerning the product or system in the current product catalog. Due to the variety of operating conditions and applications for these products or systems, the user, through its own analysis and testing, is solely responsible for making the final selection of the products and systems and assuring that all performance, safety and warning requirements of the application are met. The products described herein, including without limitation, product features, specifications, designs, availability and pricing, are subject to change by Parker Hannifin Corporation and its subsidiaries at any time without notice.

SALE CONDITIONS

The items described in this document are available for sale by Parker Hannifin Corporation, its subsidiaries or its authorized distributors. Any sale contract entered into by Parker will be governed by the provisions stated in Parker's standard terms and conditions of sale (copy available upon request).



Prevents unnecessary downtime.

Increases product output by reducing plant downtime.

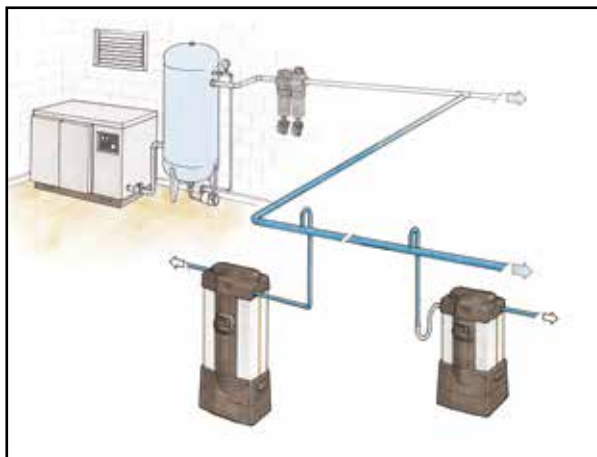

The Benefits are obvious

- **Point Of Use Application.**
Bringing Clean Dry Air just where you need it.
- **Approved to International Standards**
Designed in accordance with ASME VIII Div.1, approved to CSA/UL/CRN and fully CE Marked (PED, EMC, LVD) as standard.
- **Simple to install**
Flexible installation utilising the multiple in-line inlet & outlet connection ports.
- **Compact and lightweight.**
Can be Floor, Bench or Wall/Canopy mounted.
- **Very Quiet Operation.**
Noise level less than 70dB(A).
- **Can be installed almost anywhere.**
IP66 / NEMA 4 protection as standard.
- **Audible alarm.**
Indicating Service interval for optimal performance.
- **Simple & easy to maintain.**
A 100% service can be achieved insitu in under 15 minutes due to the quick release top cap arrangement, which does NOT require the inlet / outlet ports to be disconnected as with traditional systems.

The P3TJ Dry Air System, is the reliable, cost effective and flexible way to provide Clean Dry Air exactly where needed.



Easy desiccant cartridge replacement



Seven models in range

Features

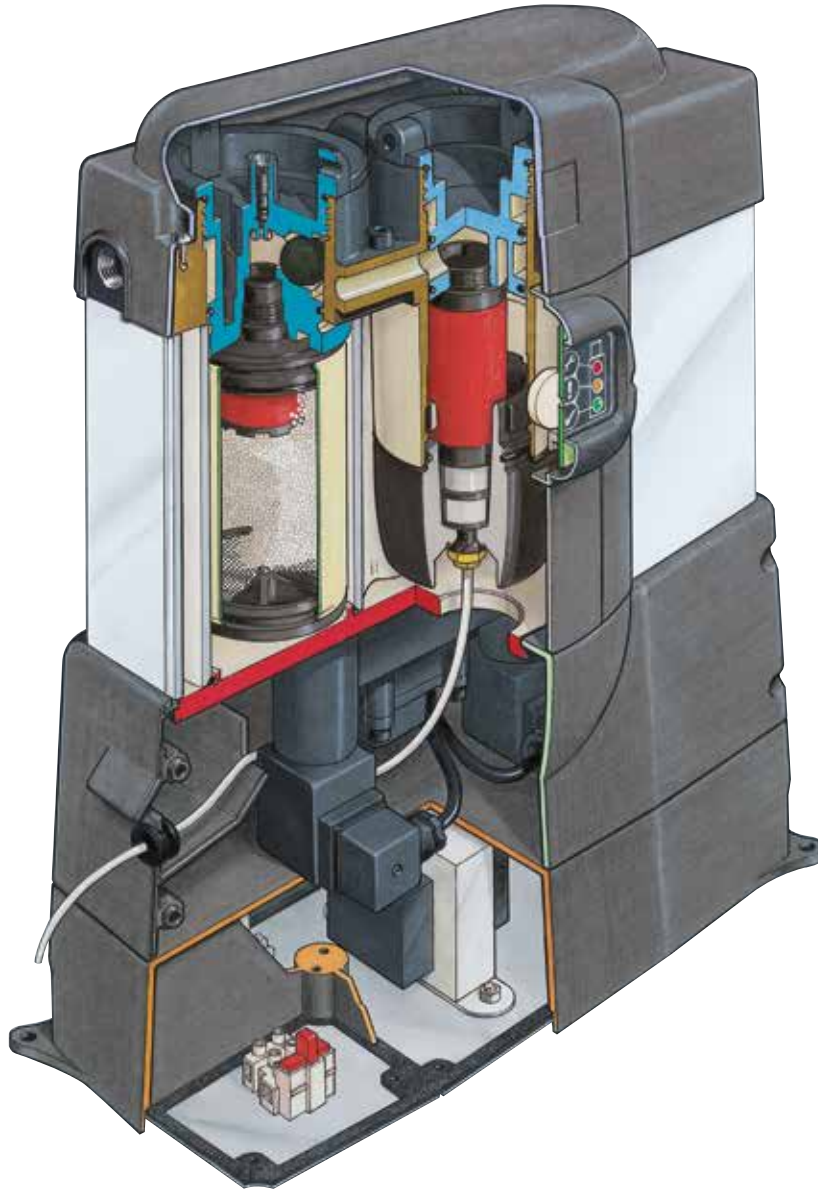

ISO7000 inlet & outlet symbols cast into the top cover ensure correct piping installation.

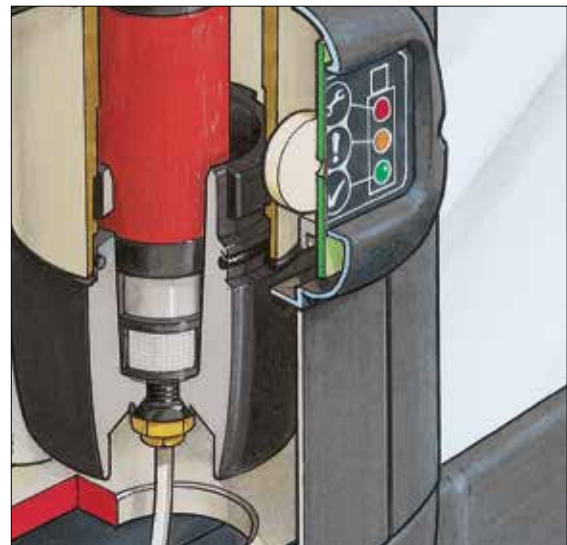

Integral 0.01µm high efficiency filter.

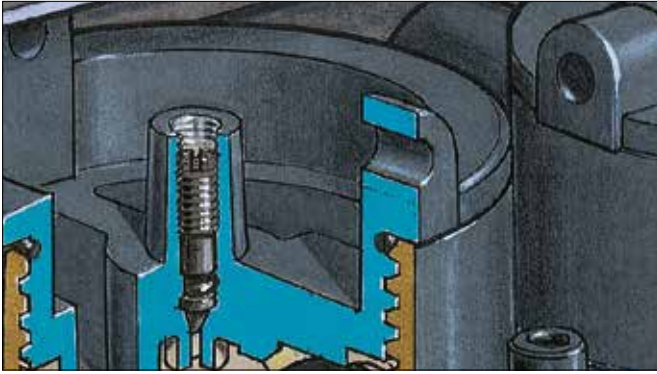

Top End Repressurisation – ensuring uninterrupted compressed air at all times.

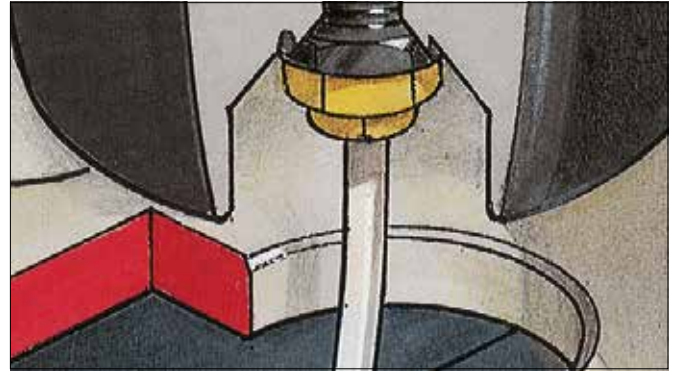

Positive removal of prefilter condensate by piping away for remote collection.

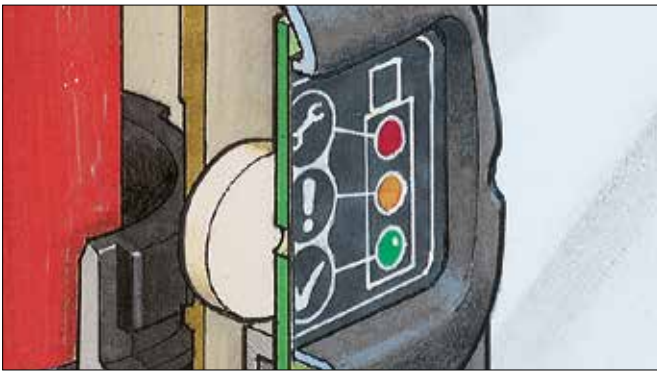

Electronic display providing high visibility LED indication with an internal audible alarm.

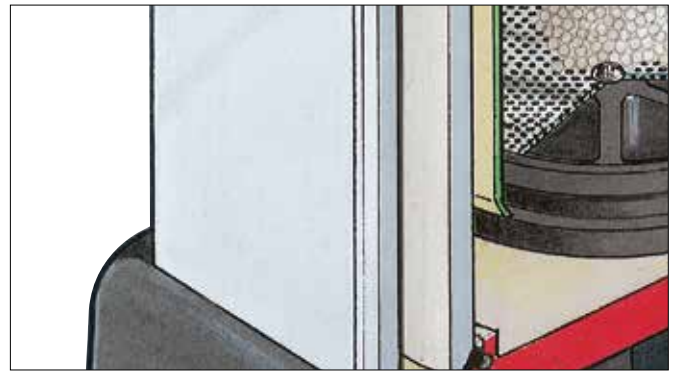

Patented high tensile extruded aluminium column with twin drying chambers.

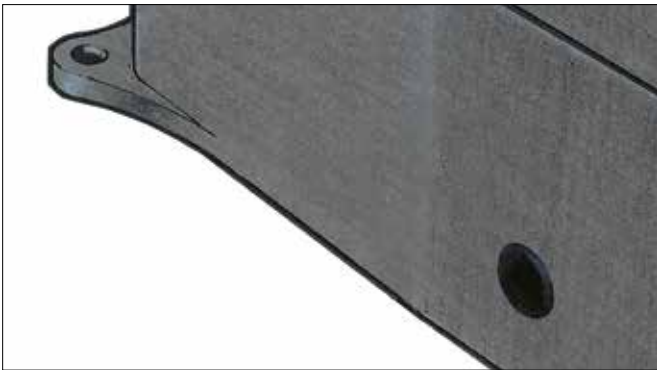

Alarm reset facility to cancel the audible alarm for 24 hours while replacement components are sourced.

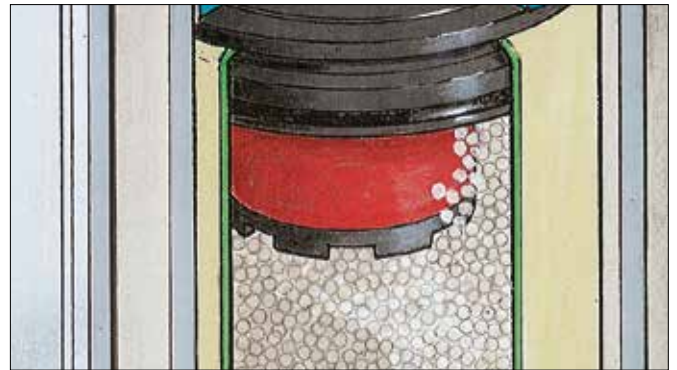

One Combi-Cartridge per column containing DRYFIL® MS desiccant and a 1µm particulate filter.

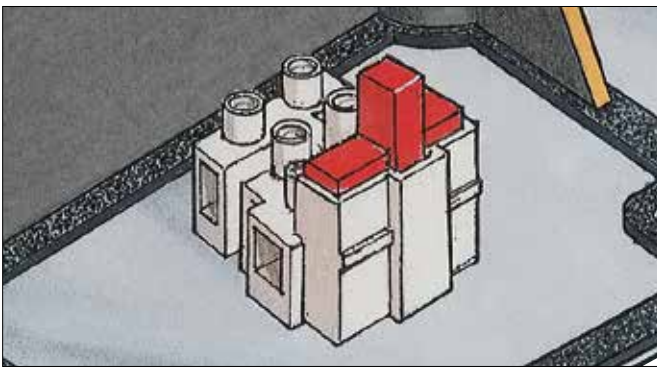

Easy access to electronic control box for mains connection.

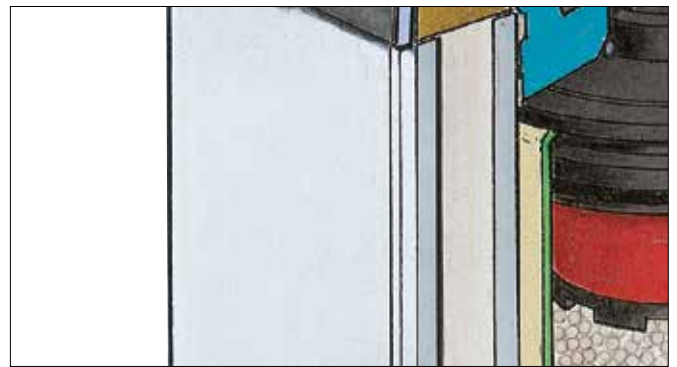

Corrosion protected by alocrom and epoxy painting.

Optional Features

- For totally quiet operation, the regeneration exhaust air can be positively piped away.
- Remote indication provides a warning of the dryers need for servicing. (Audible alarm not included)
- Wall mounting kit for vertically securing the dryer to a wall or canopy.



Tilt mounting kit facilitates easy cartridge replacement

A 45° tilt, wall mounting kit is also available for vertically securing the dryer to a wall, canopy or inside a customers product where access to the top of the dryer is restricted.

- In conditions of limited access, the electronic control box (base) can be detached and relocated remotely from the dryer.



Electronic control box can be remotely located

Product Applications

The P3TJ Dry Air System will benefit users who have a specific need for Clean Dry Air (CDA) directly after a compressor, or for a particular application where the air is critical to the operating process or end product.



P3TJ Dry Air System installed to supply control air for a CNC machining centre

Typical Applications:

- Computer Numerical Control (CNC) Machines
- Co-ordinate Measuring Machines
- Laboratories
- Lasers
- Packaging Machines
- Instrumentation
- Processing equipment
- Conveying Machines

Operation

1 Compressed air enters the integral pre-filter and passes into the left hand chamber (Column A) where the air is dried before passing to the application.

A small amount of dry purge air is used to regenerate the right hand chamber (Column B) which is wet, using the PSA (Pressure Swing Adsorption) method of regeneration, venting the saturated air to atmosphere under pressure. The same regeneration air is also used to “back flush” the integral filter to prolong its working life.

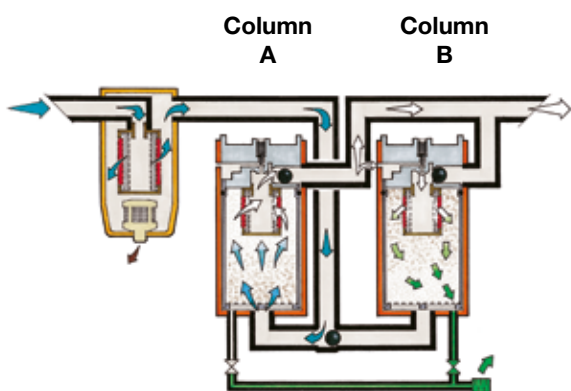

Service Indication Sequence & Alarm

During operation, The P3TJ Dry Air System Power On (yellow) LED and Check (Green) LED indicators will illuminate, remaining in this configuration for 11500 hours. At this time, the Warning (Yellow) LED will illuminate and cancel the Check (Green) LED. This signals the user to order service replacement components at the optimum time.

500 hours later (a total of 12000 hours from initial start up) the Service (Red) LED will illuminate and cancel the Warning (Yellow) LED, the Audible Alarm housed inside the display will sound intermittently (every 6 seconds) drawing attention to the need for a service.



2 Prior to changeover, the right hand chamber (Column B) enters repressurisation where the exhaust valve is closed to allow pressure to increase.

This process ensures a smooth uninterrupted changeover, preventing the loss of any system pressure, before the process repeats itself.

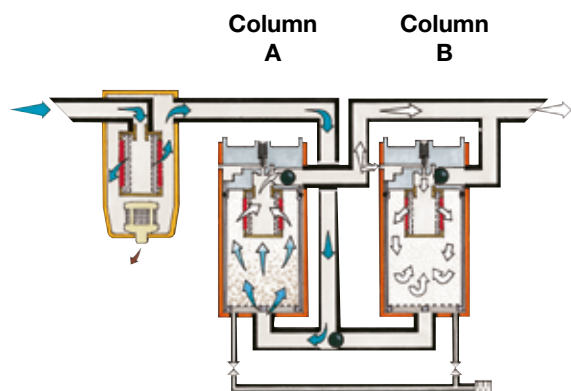

Selection Criteria

To correctly select the dryer best suited for your application, the following details are required to ensure optimum performance and trouble free operation.

- **Maximum Inlet Flow.**
- **Minimum Inlet Pressure.**
- **Maximum Inlet Temperature.**

Once these operating parameters have been established, you can select the most economical P3TJ Dry Air System for your application.



Technical Specifications

Flow Range:	85 L/min to 567 L/min at 7 bar	
Minimum Operating Pressure:	4 bar	
Maximum Operating Pressure:	12 bar	
Minimum Operating Temperature:	1.5°C	
Maximum Inlet Temperature:	50°C	
Noise Level (Average):	≤ 70dB(A)	
Pressure Dewpoint	(Standard):	-40°C pdp
	(Optional):	-70°C pdp
Standard Electrical Supply:⁺	230/1ph/50Hz (Tolerance +/- 10%)	
	115/1ph/60Hz (Tolerance +/- 10%)	
Controls:	Electronic Control Timer	
Inlet Connections:	G3/8*	
Outlet Connections:	G3/8*	

Order Code

P3	T	J	A	Thread Type		3	A	Size	Supply Voltage	N
				1	(BSPP)			1	A	(230 V AC)
				9	(NPT)			2	C	(24 V AC)
								3	J	(110 V AC)
								4		
								5		
								6		
								7	Standard Options	

P3TJ Dry Air SystemStandard nominal flow rate q_{nN} (NL/min) at pressure dew point -40°C

Model	Port Size	Max inlet temperature	Inlet Pressure (bar)								
			4	5	6	7	8	9	10	11	12
P3TJA13A1AN	3/8"	20°C	53	63	75	85	82	92	100	110	118
	3/8"	35°C	33	47	66	85	80	99	118	142	165
	3/8"	40°C	32	46	64	82	77	97	114	138	160
	3/8"	45°C	29	42	58	75	70	87	104	125	145
	3/8"	50°C	24	35	48	62	58	73	86	103	142
P3TJA13A2AN	3/8"	20°C	90	107	125	142	137	153	167	183	198
	3/8"	35°C	57	80	110	142	133	165	197	236	277
	3/8"	40°C	55	78	106	138	129	161	190	229	269
	3/8"	45°C	50	71	96	125	116	145	174	209	244
	3/8"	50°C	41	59	80	104	97	121	144	172	238
P3TJA13A3AN	3/8"	20°C	143	170	200	277	220	245	267	292	317
	3/8"	35°C	90	128	176	227	213	265	315	377	444
	3/8"	40°C	87	124	170	220	207	257	304	365	431
	3/8"	45°C	79	112	154	200	187	233	278	333	390
	3/8"	50°C	66	94	128	166	156	194	230	274	380
P3TJA13A4AN	3/8"	20°C	178	213	250	283	275	307	335	365	397
	3/8"	35°C	112	160	220	283	267	332	395	471	556
	3/8"	40°C	109	155	213	275	259	322	382	456	540
	3/8"	45°C	98	141	193	249	234	292	348	416	488
	3/8"	50°C	82	117	160	207	195	243	288	343	476
P3TJA13A5AN	3/8"	20°C	232	277	323	368	357	398	435	475	515
	3/8"	35°C	146	208	284	368	346	430	513	613	721
	3/8"	40°C	142	202	275	357	336	418	496	594	700
	3/8"	45°C	128	183	249	324	303	378	452	542	633
	3/8"	50°C	107	152	207	269	253	314	374	447	618
P3TJA13A6AN	3/8"	20°C	268	318	373	425	412	458	502	548	595
	3/8"	35°C	169	239	328	425	400	495	592	707	833
	3/8"	40°C	163	232	317	412	387	481	572	685	809
	3/8"	45°C	147	210	287	374	350	435	522	625	732
	3/8"	50°C	123	175	239	310	293	362	432	515	714
P3TJA13A7AN	3/8"	20°C	357	425	498	567	550	612	668	732	793
	3/8"	35°C	225	319	438	567	534	661	788	944	1110
	3/8"	40°C	218	310	423	550	517	643	762	915	1078
	3/8"	45°C	196	281	383	499	468	581	695	834	975
	3/8"	50°C	164	234	319	414	391	483	574	688	952

Weights and Dimensions

Model	Dimensions mm (ins) A	Weight kg (lbs)
P3TJA13A1AN	422 (16.6)	11 (24.2)
P3TJA13A2AN	500 (19.7)	13 (28.7)
P3TJA13A3AN	616 (24.2)	16 (35.3)
P3TJA13A4AN	692 (27.2)	18 (39.7)
P3TJA13A5AN	847 (33.3)	20 (44.1)
P3TJA13A6AN	906 (35.7)	23 (50.7)
P3TJA13A7AN	1098 (43.2)	28 (61.7)

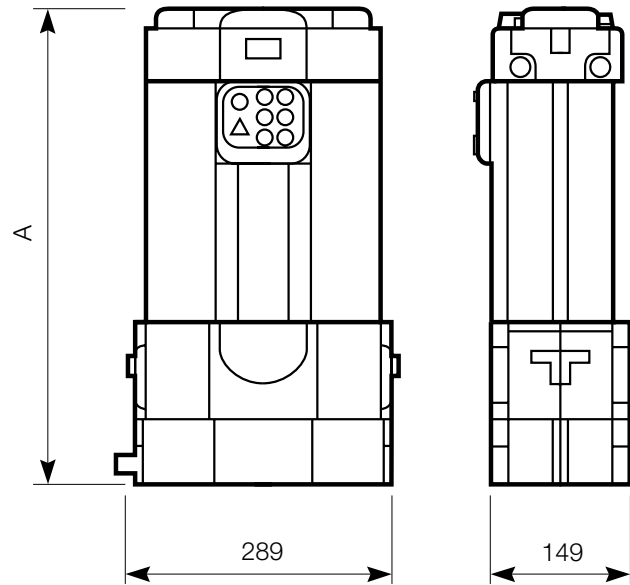

Maintenance Kits

Model	Maintenance Kit
P3TJA13A1AN	P3TKA00JA1
P3TJA13A2AN	P3TKA00JA2
P3TJA13A3AN	P3TKA00JA3
P3TJA13A4AN	P3TKA00JA4
P3TJA13A5AN	P3TKA00JA5
P3TJA13A6AN	P3TKA00JA6
P3TJA13A7AN	P3TKA00JA7

Fixing Kits

Description	Kit
Fixed Wall Mounting Bracket	P3TKA00MJ
45° Tilt Wall Mounting Bracket	P3TKA00MK

ISO 8573 - Compressed air quality standards

ISO 8573 is the group of International standards relating to the quality of compressed air and consists of nine separate parts. Part 1 specifies the quality requirements of the compressed air and parts 2 - 9 specify the methods of testing for a range of contaminants.

ISO 8573.1 : 2001 is the primary document used from the ISO 8573 series and it is this document which allows the user to specify the air quality or purity required at key points in a compressed air system.

Within ISO 8573.1 : 2001 purity levels for the main contaminants are shown in separate tables, however for ease of use, this document combines all three into one easy to understand table.

Purity Class	Solid Particulate					Water		Oil
	Maximum number of particles per m ³			Particle Size	Concentration	Vapour	Liquid	Total oil (aerosol, liquid and vapour)
	0.1 - 0.5 micron	0.5 - 1 micron	1 - 5 micron	micron	mg/m ³	Pressure Dewpoint	g/m ³	mg/m ³
0	*	*	*	*	*	*	*	*
1	100	1	0	-	-	-70°C	-	0.01
2	100,000	1,000	10	-	-	-40°C	-	0.1
3	-	10,000	500	-	-	-20°C	-	1
4	-	-	1,000	-	-	+3°C	-	5
5	-	-	20,000	-	-	+7°C	-	-
6	-	-	-	5	5	+10°C	-	-
7	-	-	-	40	10	-	0,5	-
8	-	-	-	-	-	-	5	-
9	-	-	-	-	-	-	10	-

* As specified by the equipment user or supplier

Specifying air purity in accordance with ISO 8573.1 : 2001

When specifying the purity of air required, the standard must always be referenced, followed by the purity class selected for each contaminant (a different purity class can be selected for each contaminant if required). An example of how to write an air quality specification is shown below :

ISO 8573.1 : 2001 Class 1.2.1

ISO8573.1 : 2001 refers to the standard document and its revision, the three digits refer to the purity classifications selected for solid particulate, water and total oil. Selecting an air purity class of 1.2.1 would specify the following air quality when operating at the standard's reference conditions:

Class 1 Particulate

In each cubic metre of compressed air, no more than 100 particles in the 0.1 - 0.5 micron size range are allowed
 In each cubic metre of compressed air, no more than 1 particle in the 0.5 - 1 micron size range is allowed
 In each cubic metre of compressed air, no particles in the 1 - 5 micron size range are allowed

Class 2 Water

A pressure dewpoint of -40°C or better is required and no liquid water is allowed.

Class 1 Oil

In each cubic metre of compressed air, not more than 0.01mg of oil is allowed. This is a combined level for both oil aerosol and oil vapour.

Cost effective system design

To achieve the stringent air quality levels required for today's modern production facilities, a careful approach to system design, commissioning and operation must be employed. Treatment at one point alone is not enough and it is highly recommended that the compressed air is treated prior to entry into the distribution system to a quality level suitable for protecting air receivers and distribution piping.

Point of use purification should also be employed, with specific attention being focused on the application and the level of air quality required. This approach to system design ensures that air is not "over treated" and provides the most cost effective solution to high quality compressed air.

The following table highlights the Parker Extras filtration and drying products required to achieve each air purity classification shown in ISO 8573.1 : 2001.

ISO 8573.1:2001 Class	Solid Particulate	Water Vapour	Total Oil (Aerosol Liquid & Vapour)
1	Coalescing Grade 1µm filter + Grade 0.01µm filter + Sterile filter	Adsorption Dryer -70°C PDP	Coalescing Grade 0.01µm filter + Grade 1µm filter + Vapour removal filter
2	Coalescing Grade 1µm filter + Grade 0.01µm filter	Adsorption Dryer -40°C PDP	Coalescing Grade 0.01µm filter + Grade 1µm filter
3	Coalescing Grade 1µm filter		Coalescing Grade 1µm filter

Parker Worldwide

Europe, Middle East, Africa

AE – United Arab Emirates,
Dubai

Tel: +971 4 8127100
parker.me@parker.com

AT – Austria, Wiener Neustadt

Tel: +43 (0)2622 23501-0
parker.austria@parker.com

AT – Eastern Europe, Wiener
Neustadt

Tel: +43 (0)2622 23501 900
parker.easteurope@parker.com

AZ – Azerbaijan, Baku

Tel: +994 50 2233 458
parker.azerbaijan@parker.com

BE/LU – Belgium, Nivelles

Tel: +32 (0)67 280 900
parker.belgium@parker.com

BG – Bulgaria, Sofia

Tel: +359 2 980 1344
parker.bulgaria@parker.com

BY – Belarus, Minsk

Tel: +375 17 209 9399
parker.belarus@parker.com

CH – Switzerland, Etoy

Tel: +41 (0)21 821 87 00
parker.switzerland@parker.com

CZ – Czech Republic, Klecany

Tel: +420 284 083 111
parker.czechrepublic@parker.com

DE – Germany, Kaarst

Tel: +49 (0)2131 4016 0
parker.germany@parker.com

DK – Denmark, Ballerup

Tel: +45 43 56 04 00
parker.denmark@parker.com

ES – Spain, Madrid

Tel: +34 902 330 001
parker.spain@parker.com

FI – Finland, Vantaa

Tel: +358 (0)20 753 2500
parker.finland@parker.com

FR – France, Contamine s/Arve

Tel: +33 (0)4 50 25 80 25
parker.france@parker.com

GR – Greece, Athens

Tel: +30 210 933 6450
parker.greece@parker.com

HU – Hungary, Budaörs

Tel: +36 23 885 470
parker.hungary@parker.com

IE – Ireland, Dublin

Tel: +353 (0)1 466 6370
parker.ireland@parker.com

IT – Italy, Corsico (MI)

Tel: +39 02 45 19 21
parker.italy@parker.com

KZ – Kazakhstan, Almaty

Tel: +7 7273 561 000
parker.easteurope@parker.com

NL – The Netherlands, Oldenzaal

Tel: +31 (0)541 585 000
parker.nl@parker.com

NO – Norway, Asker

Tel: +47 66 75 34 00
parker.norway@parker.com

PL – Poland, Warsaw

Tel: +48 (0)22 573 24 00
parker.poland@parker.com

PT – Portugal, Leca da Palmeira

Tel: +351 22 999 7360
parker.portugal@parker.com

RO – Romania, Bucharest

Tel: +40 21 252 1382
parker.romania@parker.com

RU – Russia, Moscow

Tel: +7 495 645-2156
parker.russia@parker.com

SE – Sweden, Spånga

Tel: +46 (0)8 59 79 50 00
parker.sweden@parker.com

SL – Slovenia, Novo Mesto

Tel: +386 7 337 6650
parker.slovenia@parker.com

TR – Turkey, Istanbul

Tel: +90 216 4997081
parker.turkey@parker.com

UA – Ukraine, Kiev

Tel: +380 44 494 2731
parker.poland@parker.com

UK – United Kingdom, Warwick

Tel: +44 (0)1926 317 878
parker.uk@parker.com

ZA – South Africa, Kempton Park

Tel: +27 (0)11 961 0700
parker.southafrica@parker.com

North America

CA – Canada, Milton, Ontario

Tel: +1 905 693 3000

US – USA, Cleveland

Tel: +1 216 896 3000

Asia Pacific

AU – Australia, Castle Hill

Tel: +61 (0)2-9634 7777

CN – China, Shanghai

Tel: +86 21 2899 5000

HK – Hong Kong

Tel: +852 2428 8008

IN – India, Mumbai

Tel: +91 22 6513 7081-85

JP – Japan, Tokyo

Tel: +81 (0)3 6408 3901

KR – South Korea, Seoul

Tel: +82 2 559 0400

MY – Malaysia, Shah Alam

Tel: +60 3 7849 0800

NZ – New Zealand, Mt Wellington

Tel: +64 9 574 1744

SG – Singapore

Tel: +65 6887 6300

TH – Thailand, Bangkok

Tel: +662 186 7000

TW – Taiwan, Taipei

Tel: +886 2 2298 8987

South America

AR – Argentina, Buenos Aires

Tel: +54 3327 44 4129

BR – Brazil, Sao Jose dos Campos

Tel: +55 12 4009 3500

CL – Chile, Santiago

Tel: +562 2303 9640

MX – Mexico, Toluca

Tel: +52 72 2275 4200

European Product Information Centre

Free phone: 00 800 27 27 5374

(from AT, BE, CH, CZ, DE, DK, EE, ES, FI,
FR, IE, IL, IS, IT, LU, MT, NL, NO, PL, PT, RU,
SE, SK, UK, ZA)



Parker Hannifin Ltd.

Tachbrook Park Drive

Tachbrook Park,

Warwick, CV34 6TU

United Kingdom

Tel.: +44 (0) 1926 317 878

Fax: +44 (0) 1926 317 855

parker.uk@parker.com

www.parker.com