



Screwdriving Technology



Automation



Air Motors



Air Tools



Belt Sanders

Power output 300 W, 500 W (.40, .67 HP)

- high power output at a low weight
- highly durable
- operates in hard-to-reach areas
- grinding of level or curved surfaces

Our belt-sanders are well-suited for the grinding, smoothing and polishing of level and curved surfaces, for the beveling of edges and the fabricating of steel, stainless-steel, brass, bronze-casting, aluminum parts, etc.

According to the requirement, we offer belts with different width from 3.5 mm to 25 mm and lengths from 305 mm to 510 mm.

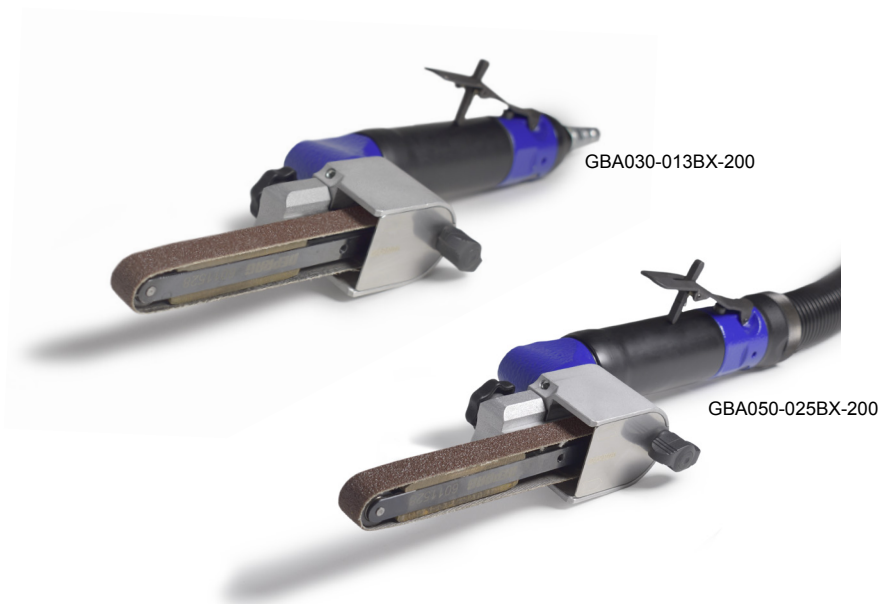

TOOLS FOR EFFECTIVE GRINDING

High power output at the smallest possible weight

All DEPRAG Industrial belt sanders excel through their compact design while simultaneously achieving a high power output. We recommend for you to actually try a tool; we believe you will be astonished by the outstanding power-to-weight ratio.

Highly durable

The compact design and the highly-developed construction in connection with the use of most-modern materials, assures the high durability of your tool - even when used in a 3-shift operation. These belt sanders are designed to perform best on heavy duty, industrial applications.

Operates in hard-to-reach areas

The specialized construction of the contact arms allows for efficient grinding, even in tight quarters. The contact arms connect to the motor of the belt-sander simply by a contact wheel.

Grinding of plain or curved surfaces

Our belt sanders are especially well-suited for the grinding of level or curved surfaces, as well as general the grinding in tight quarters.



TYPOVÝ KLÍČ

GBA 030-013 BX

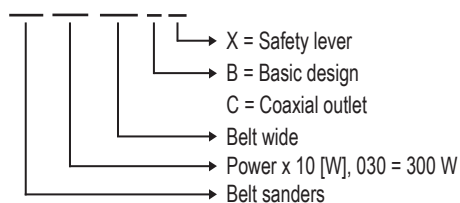

TECHNICAL DATA - BELT SANDERS - 300 W

Design

Tools can even be operated as a grinder with collet

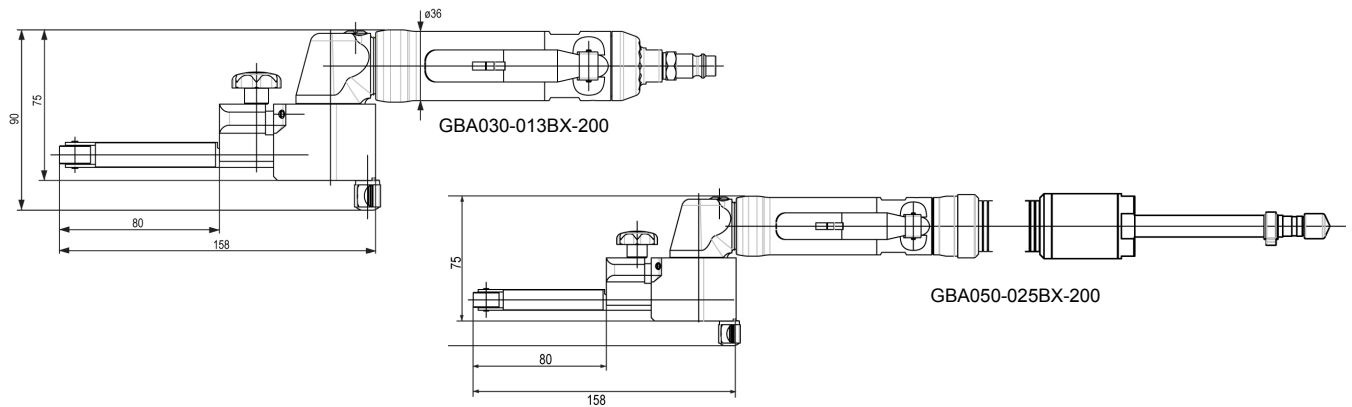







Belt Sanders	Model Part No.	GBA030-013 BX (Basic Design) 830498 A		GB 030-013 CX (Design with Exhaust Hose) 830498 B	
Speed (no load)	min ⁻¹	20 000		20 000	
Max. power output	W (hp)	300 (.40)		300 (.40)	
Air consumption (no load)	m ³ /min (cfm)	0.36 (12.72)		0.36 (12.72)	
Air consumption (under load)	m ³ /min (cfm)	0.46 (16.24)		0.46 (16.24)	
I.D. of air inlet hose	mm (in)	8 (.32)		8 (.32)	
Radial speed of grinding belt	m/s (ft/s)	19 (62.34)		28 (62.34)	
Dimension of grinding belt	mm (in)	13x305 (.53x12)		13x305 (.53x12)	
Weight	kg (lbs)	0.9 (1.98)		1.2 (2.65)	

Specifications at 90 psi (6,3 bar)

Standard Equipment:	Part Number	
Allen key 2,5 mm	800445	800445
Wrench 6/9	830649	830649
Grinding belt P60 13x305mm (5 pcs)	830686	830686
Grinding belt P80 13x305mm (5 pcs)	830687	830687
Grinding belt P120 13x305mm (5 pcs)	830688	830688
Contact arm	6011528	6011528

Optional Accessories:	Part Number	
Replacement Filter 65 µm	6078645	6078645

Accessories - Contact Arms for Belt Sanders of Type GB 030

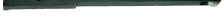
	Contact Arm (Part No.)	Grinding Belt (wide/length) in mm/in		Contact Wheel (wide / Ø / material) in mm/in		
	6011528 (Standard Equipment)	13 (1/2")	305 (12")	9 (3/8")	15 (5/8")	steel
	6017823 (Optional Accessories)	13 (1/2")	305 (12")	9 (3/8")	15 (5/8")	PolyTAN
	6017824 (Optional Accessories)	3,5; 6,5; 13 (1/8", 1/4", 1/2")	305 (12")	9 (3/8")	25 (1")	PolyTAN
	6017825 (Optional Accessories)	3,5; 6,5; 13 (1/8", 1/4", 1/2")	330 (13")	9 (3/8")	19 (3/4")	PolyTAN
	6017826 (Optional Accessories)	to 13 (1/2")	370 (15")	5 (3/16")	15 (5/8")	PolyTAN
	6017827 (Optional Accessories)	to 13 (1/2")	370 (15")	9 (3/8")	11 (7/16")	brass
	6017828 (Optional Accessories)	13 (1/2")	305 (12")	8 (5/16")	8 (5/16")	steel
	6017829 (Optional Accessories)	13 (1/2")	330 (13")	9 (3/8")	11 (7/16")	brass

SPECIFICATIONS - BELT SANDERS - 500 W

Design - with integrated speed regulator

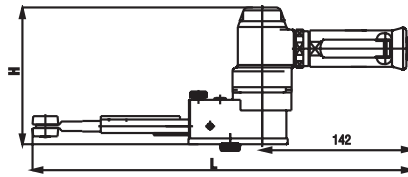









Belt Sander	Model	GB 050-025 BX	
	Part No.	6060932A	
Speed (no load)	min ⁻¹	16 000	
Max. power output	W (hp)	500	(.67)
Air consumption (no load)	m ³ /min (cfm)	0,28	(9.89)
Air consumption (under load)	m ³ /min (cfm)	0,55	(19.42)
I.D. of air inlet hose	mm (in)	10	(.39)
Radial speed of grinding belt	m/s (ft/s)	23	(75.44)
Dimension of grinding belt	mm (in)	19 x 480	(.71x19.90)
Weight	kg (lbs)	1,42	(3.13)
Dimensions LxH	mm (in)	359x130	(14.13x5.12)

Specifications at 90 psi (6,3 bar)

Standard Equipment:	Part Number
Offset key 3 mm	800446
Offset key 6 mm	800449
Grinding belt P60 19x480mm (3 pcs)	6074497
Grinding belt P80 19x480mm (3 pcs)	6074498
Grinding belt P120 19x480mm (3 pcs)	6074499
Contact arm	6017830



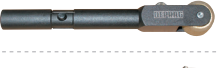

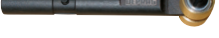
Optional Accessories:

Accessories - Contact Arms for Belt Sanders of Type GB 050

	Contact Arm (Part No.)	Grinding Belt (wide/length) in mm/in		Contact Wheel (wide / Ø / material) in mm/in		
	6017830 (Standard Equipment)	19 (3/4")	480 (19")	19 (3/4")	25 (1")	PolyTAN
	6018124 (Optional Accessories)	19 (3/4")	457 (18")	19 (3/4")	25 (1")	PolyTAN
	6018125 (Optional Accessories)	19 (3/4")	510 (20")	19 (3/4")	25 (1")	PolyTAN
	6018126 (Optional Accessories)	25 (1")	480 (19")	26 (1-1/32")	25 (1")	PolyTAN
	6018127 (Optional Accessories)	25 (1")	457 (18")	26 (1-1/32")	25 (1")	PolyTAN
	6018128 (Optional Accessories)	25 (1")	510 (20")	26 (1-1/32")	25 (1")	PolyTAN
	6018129 (Optional Accessories)	9,5 (3/8")	480 (19")	9 (3/8")	15,5 (5/8")	PolyTAN
	6018130 (Optional Accessories)	9,5 (3/8")	457 (18")	9 (3/8")	15,5 (5/8")	PolyTAN
	6018131 (Optional Accessories)	9,5 (3/8")	510 (20")	9 (3/8")	15,5 (5/8")	PolyTAN
	6018132 (Optional Accessories)	19 (3/4")	480 (19")	19 (3/4")	15,5 (5/8")	bronze



**Optional Accessories - Contact Arms for Belt Sanders of Type GB 050**

	Contact Arm (Part No.)	Grinding Belt (wide/length) in mm/in		Contact Wheel (wide / Ø / material) in mm/in		
	6018133 (Optional Accessories)	19 (3/4")	457 (18")	19 (3/4")	15,5 (5/8")	bronze
	6018134 (Optional Accessories)	19 (3/4")	480 (19")	19 (3/4")	15,5 (5/8")	bronze
	6018135 (Optional Accessories)	9,5 (3/8")	480 (19")	9 (23/64")	11 (7/16")	bronze
	6018136 (Optional Accessories)	9,5 (3/8")	457 (18")	9 (23/64")	11 (7/16")	bronze
	6018137 (Optional Accessories)	9,5 (3/8")	510 (20")	9 (23/64")	11 (7/16")	bronze

DEPRAG
machines unlimited



DEPRAG CZ a.s., T. G. Masaryka 113, 507 81 Lázně Bělohrad - Czech Republic
Tel.: +420-493 771 511, Fax: +420-493 771 623, E-mail: sales@deprag.cz, Internet: www.deprag.cz

Specifications subject to change without prior notice